

DIRECTV® High-Definition Receiver/ HDTV Receiver

Operating Instructions



CAUTION
RISK OF ELECTRIC SHOCK
DO NOT OPEN



WARNING:

TO REDUCE THE RISK OF ELECTRONIC SHOCK DO NOT REMOVE COVER (OR BACK).
NO USER SERVICEABLE PARTS INSIDE.
REFER TO QUALIFIED SERVICE PERSONNEL.



THE LIGHTNING FLASH WITH ARROWHEAD SYMBOL, WITHIN AN EQUILATERAL TRIANGLE, IS INTENDED TO ALERT THE USER TO THE PRESENCE OF UNINSULATED "DANGEROUS VOLTAGE" WITHIN THE PRODUCT'S ENCLOSURE THAT MAY BE OF SUFFICIENT MAGNITUDE TO CONSTITUTE A RISK OF ELECTRIC SHOCK TO PERSONS.



THE EXCLAMATION POINT WITHIN AN EQUILATERAL TRIANGLE IS INTENDED TO ALERT THE USER TO THE PRESENCE OF IMPORTANT OPERATING AND MAINTENANCE (SERVICING) INSTRUCTIONS IN THE LITERATURE ACCOMPANYING THE APPLIANCE.

WARNING

TO PREVENT FIRE OR SHOCK HAZARDS, DO NOT EXPOSE THIS PRODUCT TO RAIN OR MOISTURE.

This product must not be exposed to dripping or splashing liquids. Objects filled with liquids, such as a vase, must not be placed on or above the product.

NOTE TO CABLE/TV/SATELLITE DISH INSTALLER:

This reminder is provided to call the cable TV system/satellite dish installer's attention to Article 820-40 of the National Electric Code (U.S.A.). The code provides guidelines for proper grounding and, in particular, specifies that the cable ground shall be connected to the grounding system of the building, as close to the point of the cable entry as practical.

REGULATORY INFORMATION : FCC PART 15

This equipment has been tested and found to comply with the limits for a Class B digital device, pursuant to Part 15 of the FCC Rules. These limits are designed to provide reasonable protection against harmful interference when the equipment is operated in a residential installation. This equipment generates, uses and can radiate radio frequency energy and, if not installed and used in accordance with the instruction manual, may cause harmful interference to radio communications.

However, there is no guarantee that interference will not occur in a particular installation. If this equipment does cause harmful interference to radio or television reception, which can be determined by turning the equipment off and on, the user is encouraged to try to correct the interference by one or more of the following measures:

- Reorient or relocate the receiving antenna.
- Increase the separation between the equipment and receiver.
- Connect the equipment into an outlet on a circuit different from that to which the receiver is connected.
- Consult the dealer or an experienced radio/TV technician for help.

This device complies with part 15 of the FCC Rules. Operation is subject to the following two conditions: (1) This device may not cause harmful interference, and (2) this device must accept any interference received, including interference that may cause undesired operation.

REGULATORY INFORMATION: FCC Part 68

Sony must make any necessary repairs to the modem portion of this equipment in order to maintain valid FCC registration. Do not attempt to repair or service the modem.

This equipment cannot be used on public coin service provided by the Telephone Company. Connection to Party Line Service is subject to state tariffs.

- This product complies with Part 68 of the FCC rules. On the back of this product is a label that contains, among other information, the FCC registration number and Ringer Equivalent Number (REN) for this product. If requested, this information must be provided to the telephone company.
- The REN is used to determine the quantity of devices that may be connected to the telephone line. Excessive RENs on the telephone line may result in the devices not ringing in response to an incoming call. Typically, the sum of the RENs should not exceed five (5). To be certain of the number of devices that may be connected to the line (as determined by the total RENs) contact the local telephone company.
- If this product causes harm to the telephone network, the telephone company will notify you in advance that temporary discontinuance of service may be required. But if advance notice isn't practical, the telephone company will notify the customer as soon as possible. Also, you will be advised of your right to file a complaint with the FCC if you believe it is necessary.
- The telephone company may make changes to its facilities, equipment, operations or procedures that could affect the operation of the product. If this happens, the telephone company will provide advance notice so you can make the necessary modifications to maintain uninterrupted service.
- Connection to party line service is subject to state tariffs. (Contact the state public utility commission, public service commission, or corporate commission for information.)
- If trouble is experienced with this product, for repair or warranty information, please contact Sony Electronics Corporation. If the product is causing harm to the telephone network, the telephone company may request that you disconnect the product until the problem is resolved.
- An FCC compliant telephone cord and modular plug is provided with this equipment. This equipment is designed to be connected to the telephone network or premises wiring using a compatible modular jack which is Part 68 compliant. See installation instructions for details.

If you have questions about this Sony product, please contact the **Sony Satellite System Information Center at 1-800-838-SONY(7669)**. For questions about service, programming or billing, contact **DIRECTV at 1-800-DIRECTV (347-3288)**.

Declaration of Conformity
 Trade Name: Sony
 Model No.: SAT-HD200
 Responsible Party: Sony Electronics Inc.
 Address: 680 Kinderkamack Road, Oradell, NJ 07649
 Telephone No.: 201-930-6972

CAUTION

DO NOT ATTEMPT TO MODIFY THIS PRODUCT IN ANY WAY WITHOUT WRITTEN AUTHORIZATION FROM SONY ELECTRONICS CORPORATION. UNAUTHORIZED MODIFICATION COULD VOID THE USER'S AUTHORITY TO OPERATE THIS PRODUCT. THIS EQUIPMENT IS INTENDED TO RECEIVE AND DECODE SIGNALS TRANSMITTED ACCORDING TO ATSC DIGITAL TELEVISION STANDARD A/53, DIRECTV® SPECIFICATION AND IS INTENDED TO BE USED WITH AN APPROPRIATE ANTENNA, DISH AND DISPLAY DEVICE THAT YOU MUST PROVIDE.

Dolby Digital®
 Manufactured under license from Dolby Laboratories.
 "Dolby" and the double-D symbol are trademarks of Dolby Laboratories.
 Confidential Unpublished Works. ©1992-1997 Dolby Laboratories, Inc. All rights reserved.

IMPORTANT SAFETY INSTRUCTIONS

CAUTION: PLEASE READ AND OBSERVE ALL WARNINGS AND INSTRUCTIONS IN THIS OWNER'S MANUAL AND THOSE MARKED ON THE UNIT. RETAIN THIS BOOKLET FOR FUTURE REFERENCE.

This set has been designed and manufactured to assure personal safety. Improper use can result in electric shock or fire hazard. The safeguards incorporated in this unit will protect you if you observe the following procedures for installation, use, and servicing.

This unit does not contain any parts that can be repaired by the user.

DO NOT REMOVE THE CABINET COVER, OR YOU MAY BE EXPOSED TO DANGEROUS VOLTAGE. REFER SERVICING TO QUALIFIED SERVICE PERSONNEL ONLY.

- 1. Read these instructions.** - All these safety and operating instructions should be read before the product is operated.
 - 2. Keep these instructions.** - The safety, operating and use instructions should be retained for future reference.
 - 3. Heed all warnings.** - All warnings on the product and in the operating instructions should be adhered to.
 - 4. Follow all instructions.** - All operating and use instructions should be followed.
 - 5. Do not use this apparatus near water.** - For example: near a bath tub, wash bowl, kitchen sink, laundry tub, in a wet basement; or near a swimming pool; and like.
 - 6. Clean only with dry cloth.** - Unplug this product from the wall outlet before cleaning. Do not use liquid cleaners.
 - 7. Do not block any ventilation openings. Install in accordance with the manufacturer's instructions.** - Slots and openings in the cabinet are provided for ventilation and to ensure reliable operation of the product and to protect it from over-heating. The openings should never be blocked by placing the product on a bed, sofa, rug or other similar surface. This product should not be placed in a built-in installation such as a bookcase or rack unless proper ventilation is provided or the manufacturer's instructions have been adhered to.
 - 8. Do not install near any heat sources such as radiators, heat registers, stoves, or other apparatus (including amplifiers) that produce heat.**
 - 9. Do not defeat the safety purpose of the polarized or grounding-type plug. A polarized plug has two blades with one wider than the other. A grounding type plug has two blades and a third grounding prong. The wide blade or the third prong are provided for your safety. If the provided plug does not fit into your outlet, consult an electrician for replacement of the obsolete outlet.**
 - 10. Protect the power cord from being walked on or pinched particularly at plugs, convenience receptacles, and the point where they exit from the apparatus.**
 - 11. Only use attachments/accessories specified by the manufacturer.**
- 
- 12. Use only with the cart, stand, tripod, bracket, or table specified by the manufacturer, or sold with apparatus. When a cart is used, use caution when moving the cart/ apparatus combination to avoid injury from tip-over.**
 - 13. Unplug this apparatus during lightning storms or when unused for long periods of time.**
 - 14. Refer all servicing to qualified service personnel. Servicing is required when the apparatus has been damaged in any way, such as power-supply cord or plug is damaged, liquid has been spilled or objects have fallen into the apparatus, the apparatus has been exposed to rain or moisture, does not operate normally, or has been dropped.**

IMPORTANT INFORMATION

Due to copyright restrictions, you may not be able to view some high definition programs in high definition format using this product. If HD viewing is prohibited due to copyright restrictions, you would need to connect SD interfaces to view the program.

In certain markets, access to local channels requires a DIRECTV® Multi-Satellite Dish Antenna. For the most current information about the availability of local channels in your area, contact your retailer or visit DIRECTV.com. For access to all High Definition programming, a triple LNB Multi-Satellite dish antenna, including a Sat C LNB, is required, along with a High Definition capable DIRECTV® High-Definition Receiver and High Definition television. Satellite Dish Antenna Sold Separately.

Activation of programming may be subject to credit approval and requires valid service address, social security number and/or major credit card. Deposit or prepayment may be required. Programming subject to change. You must be physically located in the U.S. to receive DIRECTV service. DIRECTV services not available outside the U.S. DIRECTV programming is sold separately and independently of DIRECTV System hardware. A valid programming subscription is required to operate DIRECTV System hardware. Activate your DIRECTV programming today at 1-800-DIRECTV (1-800-347-3288)

DIRECTV, the Cyclone Design logo and Advanced Program Guide are trademarks of DIRECTV, Inc., a unit of Hughes Electronics Corp., and are used with permission.

Sony is a trademark of Sony.

Sony Software License Agreement

ATTENTION:USE OF THE SOFTWARE IS SUBJECT TO THE SONY SOFTWARE LICENSE TERMS SET FORTH ON PAGE 101. USING THE SOFTWARE OR THE PRODUCT IN WHICH IT IS INCORPORATED INDICATES USER'S ACCEPTANCE OF THESE LICENSE TERMS. IF THE USER DOES NOT ACCEPT THESE LICENSE TERMS,THE USER SHOULD IMMEDIATELY RETURN THE ENTIRE PRODUCT IN ITS ORIGINAL PACKAGING IN ORDER TO RECEIVE A FULL REFUND OF THE PURCHASE PRICE.

TABLE OF CONTENTS

	Safety Warning -----	1
	Important Safety Instructions -----	3
	Important Information -----	4
	Table of Contents -----	5
1. Introduction	1-1. A New World of Digital Entertainment -----	7
	1-2. Main Features -----	8
2. Important Overview	2-1. Sending Signals -----	9
	2-2. TV Signal Formats -----	10
	2-3. Display Formats -----	11
	2-4. Normal and Wide Format Signals -----	12
	2-5. Audio Signals -----	14
	2-6. On-Screen Display -----	16
3. Setup and Connections	3-1. Unpacking -----	18
	3-2. Back Panel of the DIRECTV® High-Definition Receiver -----	20
	3-3. General Recommendations -----	22
	3-4. Connecting to Antennas -----	23
	3-5. TV Connection -----	27
	3-6. VCR Connection -----	31
	3-7. Audio Connection -----	32
4. Front Panel and Remote Control	4-1. Using the Front Panel of the DIRECTV® High-Definition Receiver -----	34
	4-2. Using the Remote Control -----	35
	4-3. Programming the Remote Control -----	38
	4-4. Remote Control Codes for Other Components -----	39
5. Initial Setup -----		41
6. Basic Operation	6-1. Viewing the Channel Banner -----	42
	6-2. Surfing Favorite Channels -----	44
	6-3. Subscription to DIRECTV® programming and ANT/CABLE-Only operation -----	45

7. Advanced Program Guide™	7-1. About the Advanced Program Guide™ -----	46
	7-2. Layout of the Advanced Program Guide™ Screen --	47
	7-3. Moving through the Advanced Program Guide™ ---	48
	7-4. Selecting a Program -----	49
	7-5. Getting More Information -----	50
	7-6. Referring to Help -----	51
	7-7. Making a Remind List for Future Viewing -----	52
	7-8. Purchasing DIRECTV® Pay Per View Programs ----	53
	7-9. Searching Programs by Category -----	54
	7-10. Searching Programs by Keyword -----	55
8. Customization	8-1. The Structure of the On-screen Menu -----	56
	8-2. The On-screen Menu -----	57
	8-3. Previewing the Remind List -----	58
	8-4. Managing Program Purchases -----	59
	8-5. Checking the Messages -----	61
	8-6. Initializing the System -----	62
	8-7. Managing Channels -----	66
	8-8. Hook-up Help -----	70
	8-9. Setting the Clock -----	71
	8-10. Advanced -----	73
	8-11. Setting the Audio -----	74
	8-12. Choosing the Aspect Ratio -----	78
	8-13. Setting Closed Caption -----	80
	8-14. Setting Default Signal Out -----	81
	8-15. Setting the Digital TV Input -----	84
	8-16. Running Auto Demo -----	86
	8-17. Setting Locks -----	87
	8-18. Testing the System -----	92
	8-19. Replace Card -----	93
	8-20. Upgrading Software -----	94
9. Help -----		95
Reference	Product Specifications -----	97
	Troubleshooting -----	98
	Warranty -----	100
	Software License Agreement -----	101
	Index -----	102

1. INTRODUCTION

1-1. A New World of Digital Entertainment

Welcome to the DIRECTV® High-Definition Receiver, an advanced digital satellite receiver that showcases a new generation of digital entertainment.

Different from conventional analog broadcasts, digital broadcasts allow you to enjoy superior quality video and audio right in your own home.

The DIRECTV HD Receiver delivers a variety of programs from DIRECTV and has a built-in HDTV Receiver that serves as a digital receiver that makes it possible to view digital programs even on your analog TV.

The Advanced Program Guide™ also enables you to access and view over-the-air broadcasts and cable as well as DIRECTV® programming.



1-2. Main Features

Ultimate Entertainment

- **A Wide Variety of Programs**

Hundreds of channels are available by subscription from DIRECTV.

- **DIRECTV Advanced Program Guide™**

Instant access to up to three days of program listings.

Ability to jump a day at a time.

Ability to search and tune by program title, keyword and category.

Technical Flexibility

- **Seamless Tuning**

Tune seamlessly to over-the-air, cable and satellite.

- **Multiple Output Jacks**

Multiple output jacks are provided on the back panel of the DIRECTV® High-Definition Receiver.

- **Screen Format Adaptability**

Various screen formats are available including 1080i, 720p, 480p, video 1/2 (480i), variable 1, variable 2, variable 3, and auto DVI modes.

- **HD Formatted On-Screen Display**

Advanced look and feel for the on-screen display menu and Advanced Program Guide.

- **Software Upgrade**

Software upgrading from DIRECTV.

- **ANT/CABLE Only Mode**

Viewing analog/digital broadcasting through over-the-air antenna.

Superior Performance

- **Crisp Picture**

High-Definition or resolution with a 16:9 aspect ratio when connected to a high definition monitor.

- **Superior Sound**

Sensational sound with Dolby Digital 5.1 channels when connected to a Dolby Digital compatible audio receiver system.

Fingertip Convenience

- **Help**

Easy-to-use on-screen menus with instant spot help and brief on-screen user's guide.

- **Hook-up Help**

The on-screen menus show connection schemes on the DIRECTV HD Receiver.

2. IMPORTANT OVERVIEW

2-1. Sending Signals

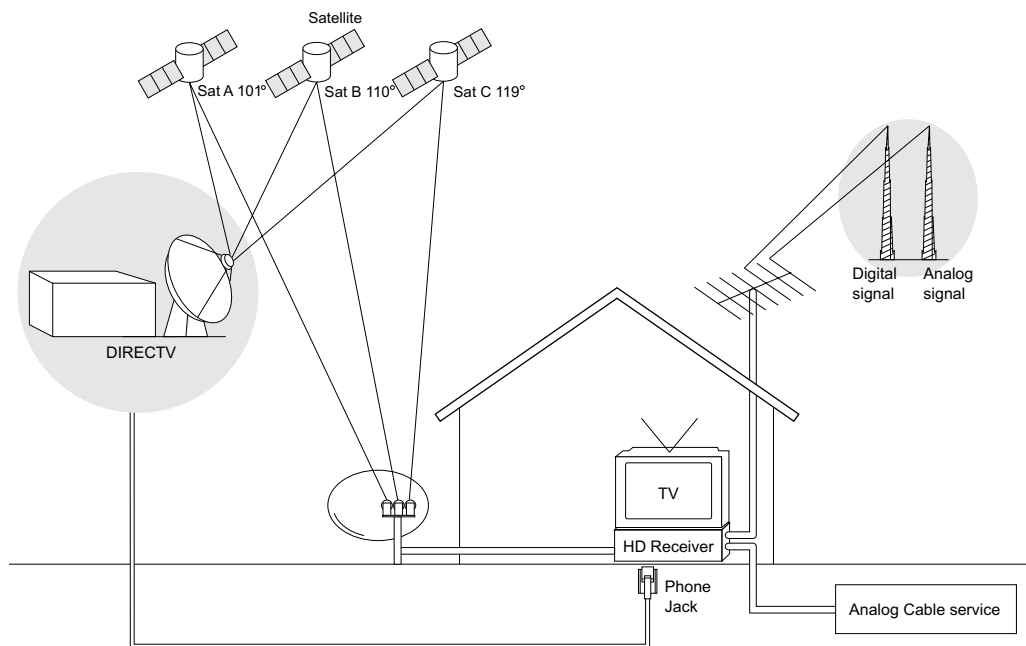

Digital broadcasting is a new way of sending programs over the airwaves with superior quality video and audio. The DIRECTV® High-Definition Receiver enables you to take full advantage of digital broadcasting. To fully enjoy it, you need to understand the ways the program signals are sent.

There are two types of TV signal formats; analog (often called NTSC format; National Television System Committee) and digital (ATSC format; Advanced Television System Committee). Digital formats are classified into three categories: High Definition (HD), Enhanced Definition (ED), and Standard Definition (SD) according to the resolution or digital picture quality.

There are also three ways that program signals can be received; over-the-air (NTSC, ATSC), cable, and satellite.

2-2. TV Signal Format

Standard Comparison Table

Signal Format	Analog (NTSC)	Digital (ATSC/DIRECTV)	
		SD	HD
Active Lines	480i	480p	720p or 1080i
Sound	Stereo (2 ch)	Dolby Digital (5.1 ch) MPEG Audio (2 ch)	Dolby Digital (5.1 ch)
Aspect Ratio	4 : 3	4 : 3 or 16 : 9	16 : 9
Resolution	720 x 480	640 x 480 704 x 480	1280 x 720 1920 x 1080

The digital TV standards allow several different formats. Broadcasters can choose between three formats:

- 480p - The picture is 704 x 480 pixels, sent at 60 complete frames per second (480i is also possible).
- 720p - The picture is 1280 x 720 pixels, sent at 60 complete frames per second.
- 1080i - The picture is 1920 x 1080 pixels, sent at 60 interlaced frames per second (30 complete frames per second).

(The “p” and “i” designations stand for “progressive” and “interlaced.” In a progressive format, the full picture updates every sixtieth of a second. In an interlaced format, half of the picture updates every sixtieth of a second.)

The 480p and 480i formats are called the SD formats, and 480i is roughly equivalent to a normal analog TV picture. The 720p and 1080i formats are called the HD formats.







Some NTSC televisions can display a picture 720 pixels wide by 480 pixels high, that’s a total of 345,600 pixels. HD digital signals can have a maximum resolution of 1920 x 1080, that’s 2,073,600 pixels, or six times more pixels than the older resolution. Pictures will be crisper and cleaner, with more detail in every close-up and every panorama.

2. IMPORTANT OVERVIEW

2-3. Display Formats

The DIRECTV® High-Definition Receiver provides several display formats. The **Format** button in the front panel changes the display format in the cycle of 1080i, 720p, 480p, video1/2(480i), variable 1, variable 2, variable 3 and Auto DVI modes. In **1080i, 720p, 480p** and **video 1/2(480i)** modes, all input signal formats are converted to the chosen display format. In **variable 1, variable 2** and **variable 3** modes, output display format is automatically adapted depending on input signal format. In **Auto DVI** mode, the output display format is automatically adapted depending on the type of monitor that is connected.

Display Format modes	Input Signal format	Output Display format
1080i	all formats	1080i
720p	all formats	720p
480p	all formats	480p
video 1/2(480i)	all formats	480i
variable 1	480i/480p	480p
	720p	720p
	1080i	1080i
variable 2	480i/480p	480p
	720p/1080i	1080i
variable 3	480i/480p	480p
	720p/1080i	720p
Auto DVI*	all formats	changes according to monitor type

OUTPUT CONNECTION	AVAILABLE FORMATS
YPbPr 	1080i/720p/480p/Variable 1/Variable 2/Variable 3
RGB 	1080i/720p/480p/Variable 1/Variable 2/Variable 3
DVI-HDTV 	1080i/720p/480p/Variable 1/Variable 2/Variable 3/Auto DVI*
Video 1 / 2 	Video 1 / 2
S Video 	Video 1 / 2
RF Out to TV 	Video 1 / 2

*Format available when using the DVI-HDTV output to connect to a DVI-HDTV monitor.

2-4. Normal and Wide Format Signals

When you view a high definition picture with 480i or 480p format setting, the wide mode button on the remote control changes the wide mode in the cycle of Letterbox, Cropped, to Squeezed.

When you view a standard definition picture with 720p or 1080i format setting, the wide mode button on the remote control changes the wide mode in the cycle of Normal, Wide, Panorama, Zoom1, to Zoom2. (Refer to section 8.12, 'Choosing the Aspect Ratio')

WHEN YOU SET THE FORMAT TO SDTV (480i/480p)

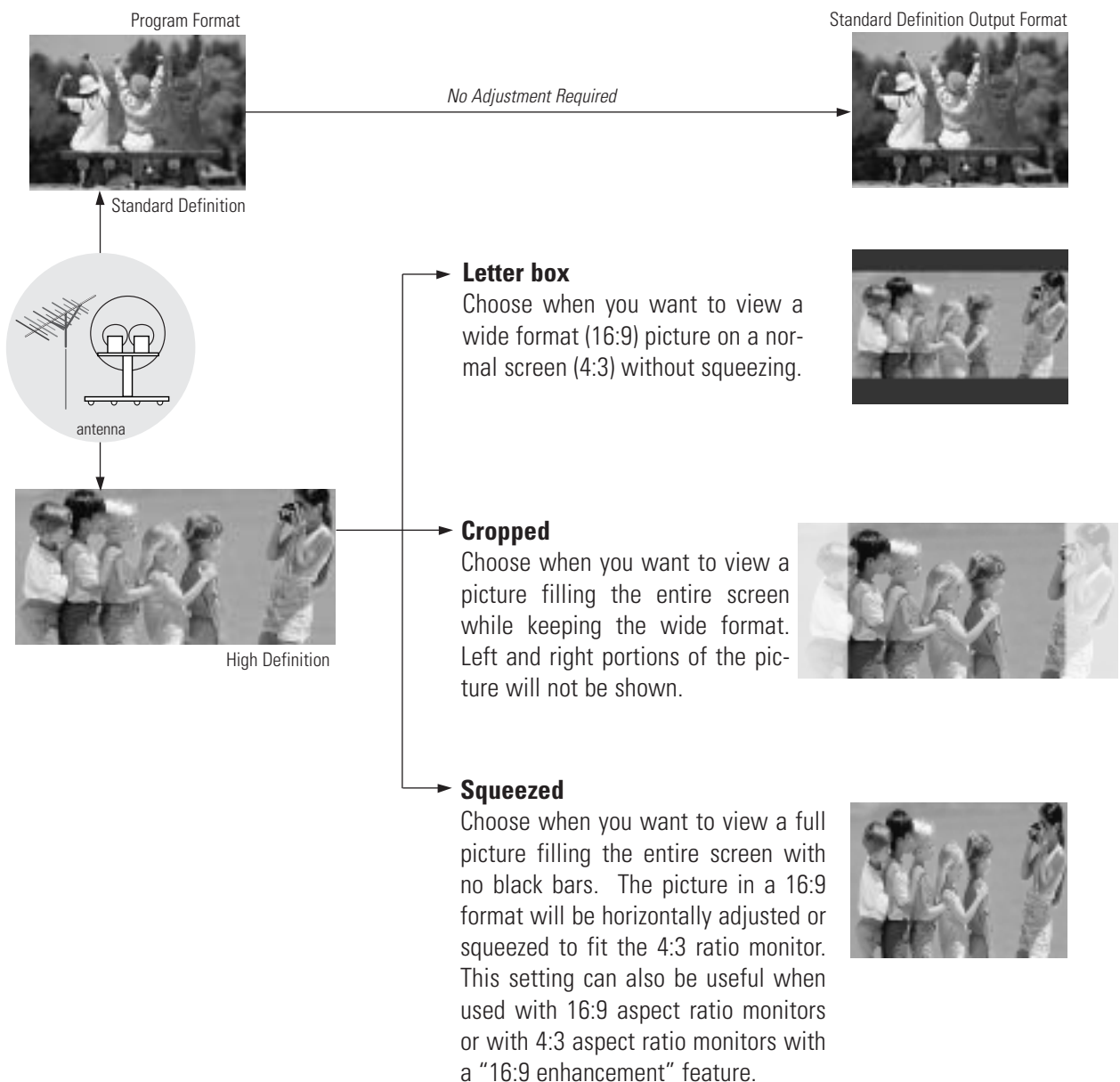

2. IMPORTANT OVERVIEW

2-4. Normal and Wide Format Signals

WHEN YOU SET THE FORMAT TO HDTV (1080i/720p)

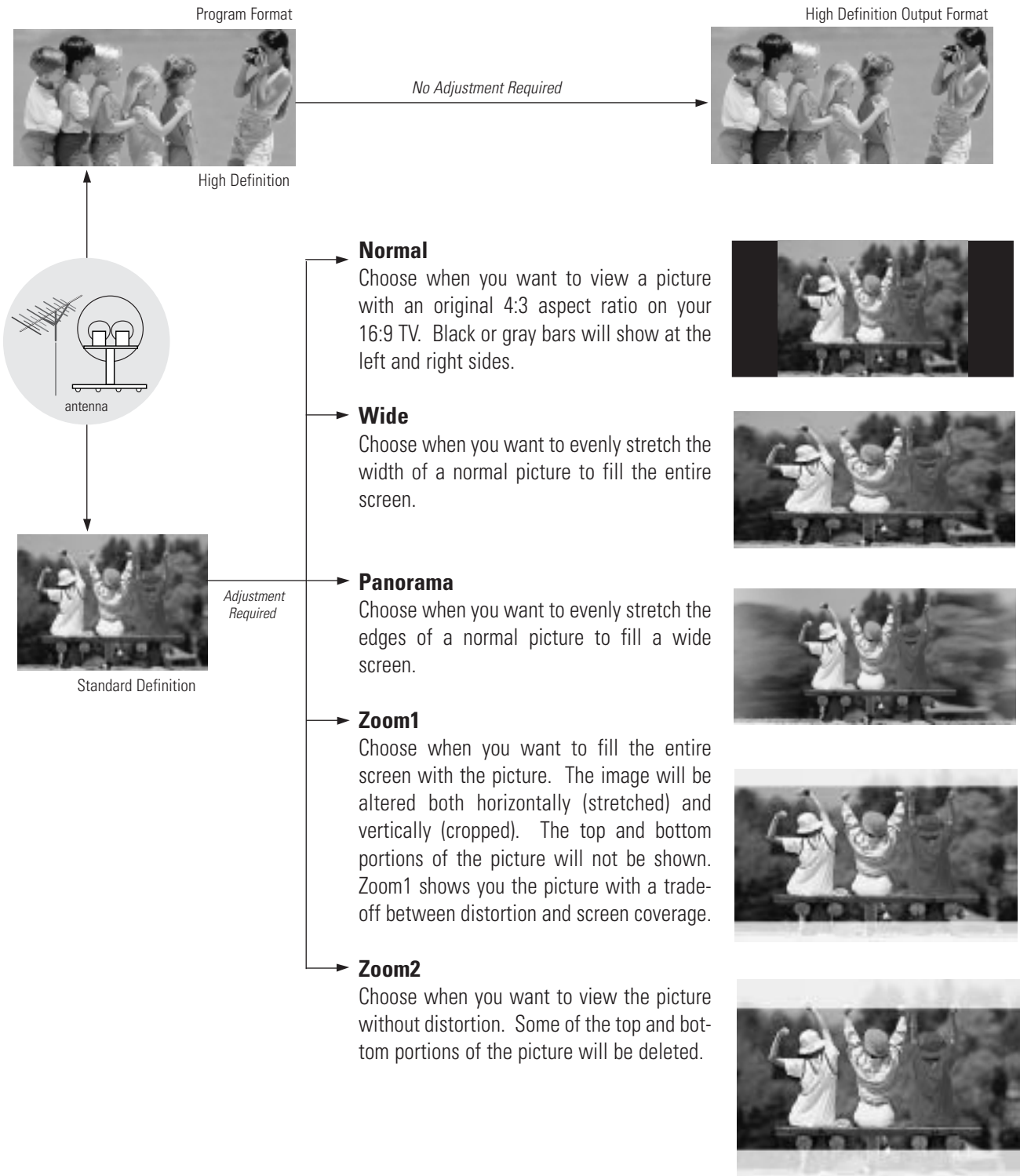

2-5. Audio Signals

Digital Audio Signals

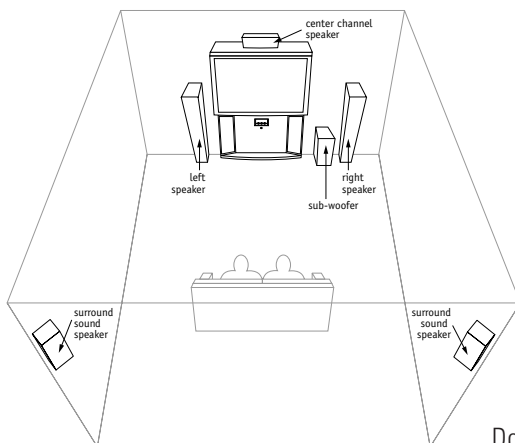

Dolby Digital Sound with 5.1 Channels

The DIRECTV® High-Definition Receiver will be the focal center of your home entertainment system comprising a variety of components, such as TV, DVD, VCR, etc. and external audio systems. Since digital programs being broadcast contain digital-quality audio, you can create a home theater by sending audio signals from the DIRECTV HD Receiver to your audio system externally. HD digital signals use the Dolby Digital audio encoding system - the same digital sound used in many movie theaters, on DVDs, and in many home theater systems.

When you tune to a channel, the DIRECTV HD Receiver can send signals either to a Dolby Digital decoder/receiver or to a PCM (normal digital) decoder. (* Refer to Section 3.7 Connection for Audio for making the required external connections to your system.)

GLOSSARY

Dolby Digital, formally known as AC-3 for Audio Coding 3rd Generation or "5.1" channel audio, is a coding technique that can provide up to five independent, full frequency response audio channels (three in left, center, and right, two in rear left and right, and one low frequency effect for a sound you can feel).

2. IMPORTANT OVERVIEW

2-5. Audio Signals

Analog Audio Signals

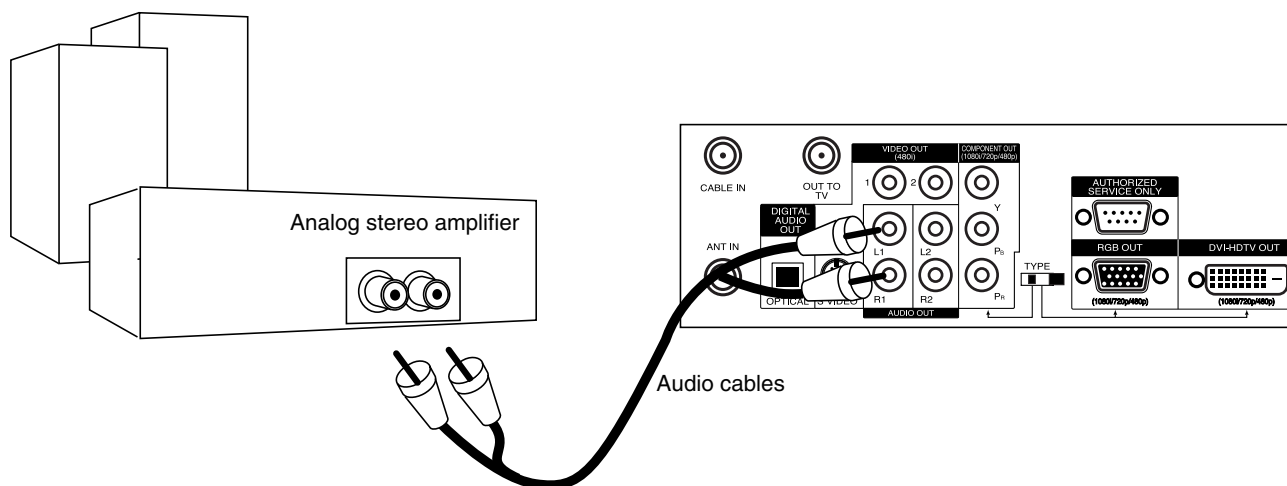

The analog audio outputs may be used to drive an external Hi-Fi audio system instead of the TV speakers. These stereo outputs are activated by setting the Analog Mode in the Audio menu to Stereo.

If you set the Analog Mode to SAP (Second Audio Program), you can hear the program's dialog in another language such as French or Spanish, if provided on the broadcast.

2-6. On-Screen Display

Main Menu

You can adjust the setup through a user-friendly on-screen menu using the remote control. While viewing a program, the on-screen menu will appear on your TV screen if you press the **Menu** button on your remote control. The on-screen menu is operated using a simple, straight-forward 'Highlight and Select' process. You just highlight a menu item by using "▲▼◀▶" on your remote control, and select it by pressing "+". The on-screen menu also offers visual cues for easy guidance.



Advanced Program Guide™

The DIRECTV Advanced Program Guide™ is an on-screen listing of current and future programs that are available from DIRECTV. The DIRECTV® High-Definition Receiver offers you a comprehensive program list that contains information about programs with hundreds of channels, including analog Antenna and digital (ATSC). If you do not subscribe to DIRECTV® programming, you will not be able to see the APG.



2. IMPORTANT OVERVIEW

2-6. On-Screen Display

Help

First, certain features and terminologies used in the on-screen menus require your basic understanding to fully utilize their capabilities. The DIRECTV® High-Definition Receiver provides a powerful feature called “Help” that describes highlighted menu item to help you understand the features. Press and hold the “**Help**” button to display the “Help”. Once you release the button, the Help menu disappears from the screen.

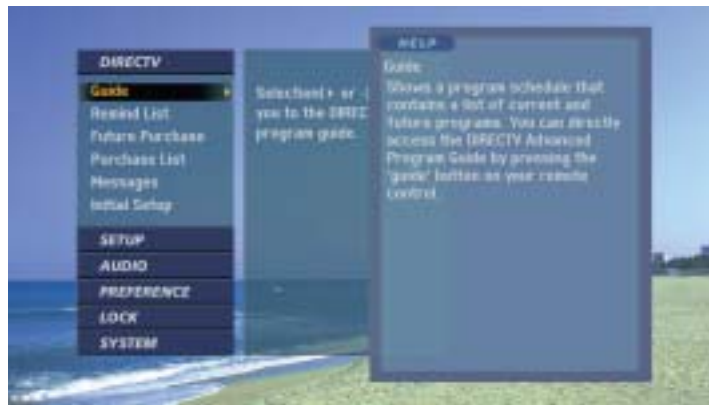

Second, if you press the “**Help**” button while you are viewing a program with no menus on - screen, the DIRECTV HD Receiver provides a comprehensive on-screen user’s guide. It describes how to use your receiver.

This is, in fact, an on-line version of this Operating Guide.



3. SETUP AND CONNECTIONS

3-1. Unpacking

Make sure you have received all these items listed below with the DIRECTV® High-Definition Receiver.



Remote Control

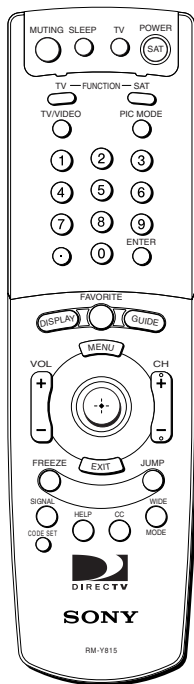

Cables

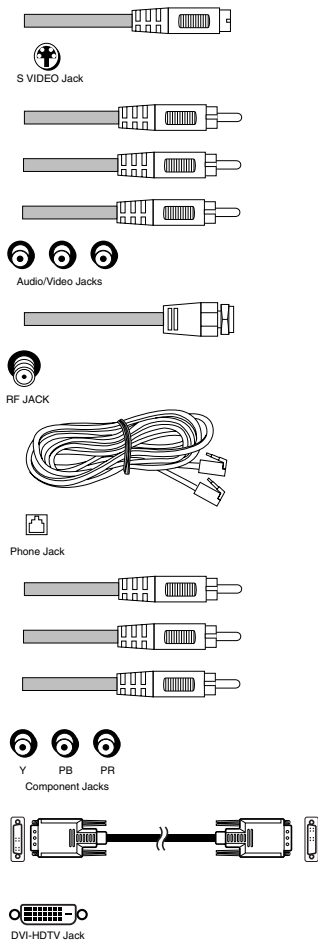

Batteries

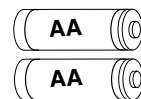

Access Card



3. SETUP AND CONNECTIONS

3-1. Unpacking

DIRECTV® High-Definition Receiver

The DIRECTV HD Receiver is capable of receiving signals from the satellite dish, cable, and/or over-the-air antenna and sending the decoder signals to your TV.

Remote Control

In addition to the DIRECTV HD Receiver, the remote control can be programmed to control many other devices.

Batteries

To install the batteries, slide open the battery compartment and insert the two AA batteries provided.

S-Video Jack and Cable

An S-Video jack is provided on the DIRECTV HD Receiver and is used together with audio cables. Remember to connect the left and right audio cables. An S-Video jack carries only the picture signals, not the sound.

Audio/Video Jacks and Cables

The Audio/Video jacks provide excellent picture and sound quality. They are used for making most Audio/Video connections between components. The Audio/Video jacks may be color coded (yellow for video, red for right audio, and white for left audio). If your component has only one input for audio (mono), connect it to the left (white L/mono) audio jack on the DIRECTV HD Receiver.

RF (Radio Frequency) Jacks and Coaxial Cables (F-type)

RF jacks are necessary for reception of over-the-air broadcasts, cable, and DIRECTV signals. These jacks are also required for antenna or cable connections. The RF and coaxial jacks on the DIRECTV HD Receiver are labeled Antenna, Cable, Satellite and OUT TO TV. An RG-6 type coaxial cable is required for satellite signal distribution.

Telephone Jack and Cord

A telephone line cord is required to connect the DIRECTV HD Receiver to a phone line. If you choose to subscribe to DIRECTV® programming, this phone line is required to be connected.

Component Out Jacks and Cables

Component Cables are used to connect the DIRECTV HD Receiver to an industry standard Y/PB/PR compatible Monitor.

DVI-HDTV port and Cable

DVI cable is used to connect the DIRECTV HD Receiver to an DVI-HDTV compatible HD monitor that supports HDCP.

Access Card

Access Card is the means by which DIRECTV controls the distribution of its service. The card must be inserted into the access card slot (on the rear of the DIRECTV HD Receiver) at all times to ensure reception of satellite signals.

3-2. Back Panel of the DIRECTV® High-Definition Receiver

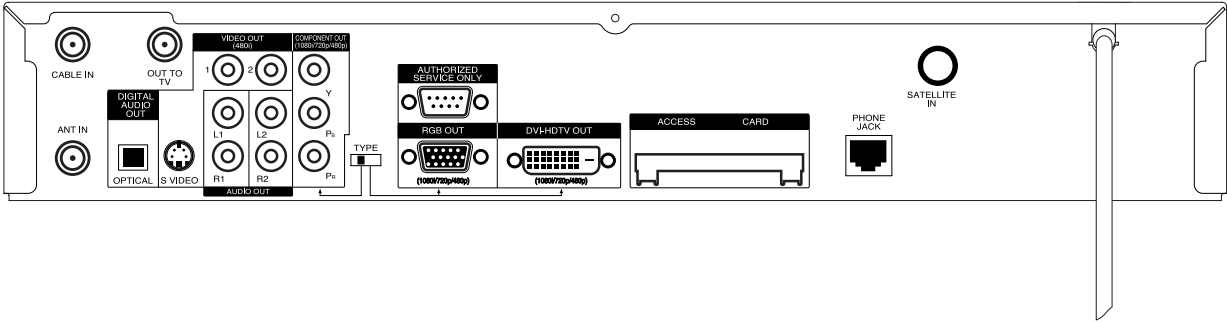

3. SETUP AND CONNECTIONS

3-2. Back Panel of the DIRECTV® High-Definition Receiver

Ant In

Is used to connect an over-the-air or terrestrial antenna.

Cable In

Is used to connect a coaxial cable coming from your analog cable TV service outlet or cable box.

Out to TV

Provides an RF connection between the DIRECTV HD Receiver and the TV. Decoded signals are provided on channel 3 or 4 as selected in the Output Channel section of the PREFERENCE menu. If the DIRECTV HD Receiver is in the standby mode, Cable or Antenna signals are provided as chosen in the Out to TV section of the Preference menu.

Video Out 1,2

Is used to provide baseband composite video signal to VCR or TV set. Video connection generally provides picture quality that is superior to RF connections. For the better quality picture connection, use the S-Video jack if it is available.

(Note : These outputs are only available when video 1/2 display format is selected.)

Component Out

Is used to connect to a Y/PB/PR-compatible monitor. Three video and two audio jacks for a Y/PB/PR monitor need to be connected and the **TYPE** switch must be set to left position.

(Note : This output is not available when the video 1/2 format is selected.)

RGB/DVI-HDTV Out

Is used to connect to either an RGB compatible or DVI-HDTV monitor. Either an RGB port for an RGB monitor or a DVI-HDTV port for a DVI-HDTV monitor need to be connected and the **TYPE** switch must be set to right position.

(Note : This output is not available when the video 1/2 format is selected. DVI -HDTV port has higher priority than RGB port when both are being used.)

Note: For best access to High-Definition Programming from DIRECTV, connect the DVI-HDTV output to a DVI-HDTV input on your high-definition TV or monitor. A DVI-HDTV input is one that is compliant with EIA-861 and HDCP specifications. Check your TV or monitor's user manual to find out if the TV or monitor's DVI input is compliant with these specifications.)

Audio Out 1,2

Is used to provide analog audio signals to VCR, TV set, HD Monitor, or Hi-Fi System.

Digital Audio Out

Is used to connect a digital optical cable from the DIRECTV HD Receiver to the Dolby Digital receiver or decoder. Dolby Digital enables the viewer to experience theater-quality sound using 5.1 audio channels.

Authorized Service Only

Is used only for authorized service purposes.

Access Card

Is the means by which DIRECTV controls the distribution of its services. The card must be inserted into the access card slot (on the rear of the receiver) at all times to enable reception of satellite signals.

Phone Jack

Is used to connect a phone line.

Satellite In

Is used to connect a satellite dish antenna to your receiver.

3-3. General Recommendations

CAUTION: Make all connections before plugging the power supply cord into a standard 120V, 60Hz AC power outlet.

You can connect the DIRECTV® High-Definition Receiver in a variety of configurations. The answers to the following questions will determine the correct setup for you.

- What type of antennas do you have? Satellite dish, cable, and/or over-the-air antennas.
- What type of connectors does your TV or VCR have: Y/PB/PR, RGB, DVI-HDTV, S-VIDEO, A/V (RCA-type), or RF coaxial?
- Do you have an external audio or audio/video system? Consider integrating the DIRECTV HD Receiver into a home theater configuration to take advantage of the audio capabilities of your Dolby Digital System (Digital) or Hi-Fi System (Analog).
- Does your TV have Y/PB/PR connectors? Use it to connect your TV to the DIRECTV HD Receiver. An Y/PB/PR connection provides a better picture than S-VIDEO, RCA-type video, or RF connections.
- Does your TV have an S-VIDEO jack? Use it to connect your TV to the DIRECTV HD Receiver. An S-VIDEO connection provides a better picture than RCA-type video or RF connections.
- Does your TV have RCA-type A/V connectors, but no S-video jack? Use your TV's A/V connectors to connect your components. An A/V connection provides better picture and audio when compared to an RF connection.

Although there are numerous connections possible for optimum video and audio performance, try to follow the guidelines listed below when you hook up your components. Detailed hook-up instructions are provided on the following pages.

Connection	Component	Page
To Antennas	No Dish	23
	Round Dish (Satellite A)	24
	Oval Dish (Satellite A, B)	25
	Oval Dish (Satellite A, B, C)	26
To TV/Monitor	Analog TV	27
	HD Monitor (Y/PB/PR type)	28
	HD Monitor (RGB type)	29
	HD Monitor (DVI-HDTV type)	30
To A/V Systems	VCR	31
	Digital Audio System	32
	Analog Hi-Fi System	33



Protect your components from power surges by turning off the component and unplugging power cords when you make connections.

Protect your component from overheating by keeping the ventilation holes open and not stacking components.

3. SETUP AND CONNECTIONS

3-4. Connecting to Antennas - No Dish

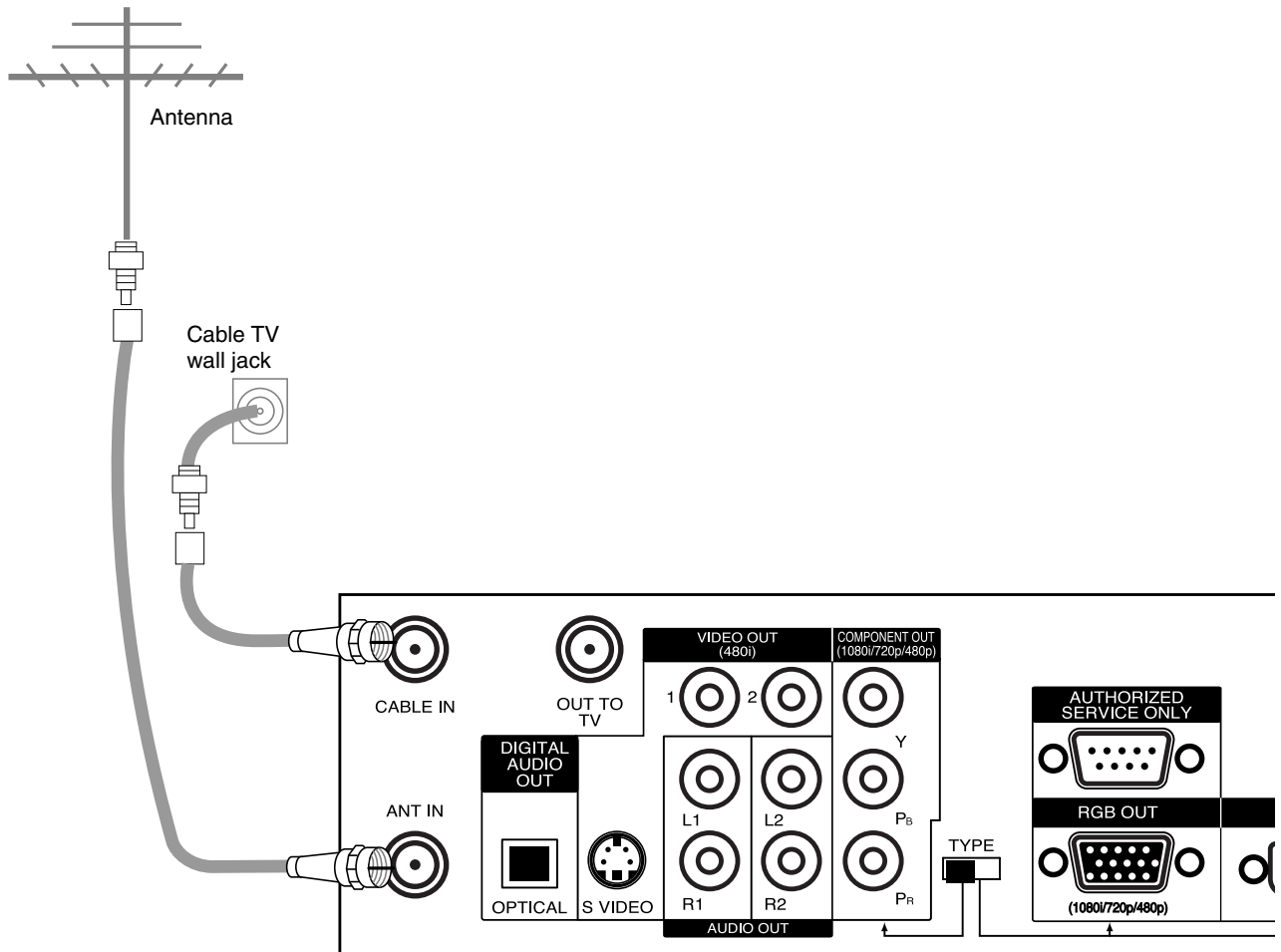

Receiving Signals

1. Connect the "Antenna" to the "ANT IN" jack on the DIRECTV® High-Definition Receiver using a coaxial RF cable.
2. Connect the cable TV signal to the "CABLE IN" jack on the DIRECTV HD Receiver using a coaxial RF cable.

3-4. Connecting to Antennas - Round Dish (Satellite A)

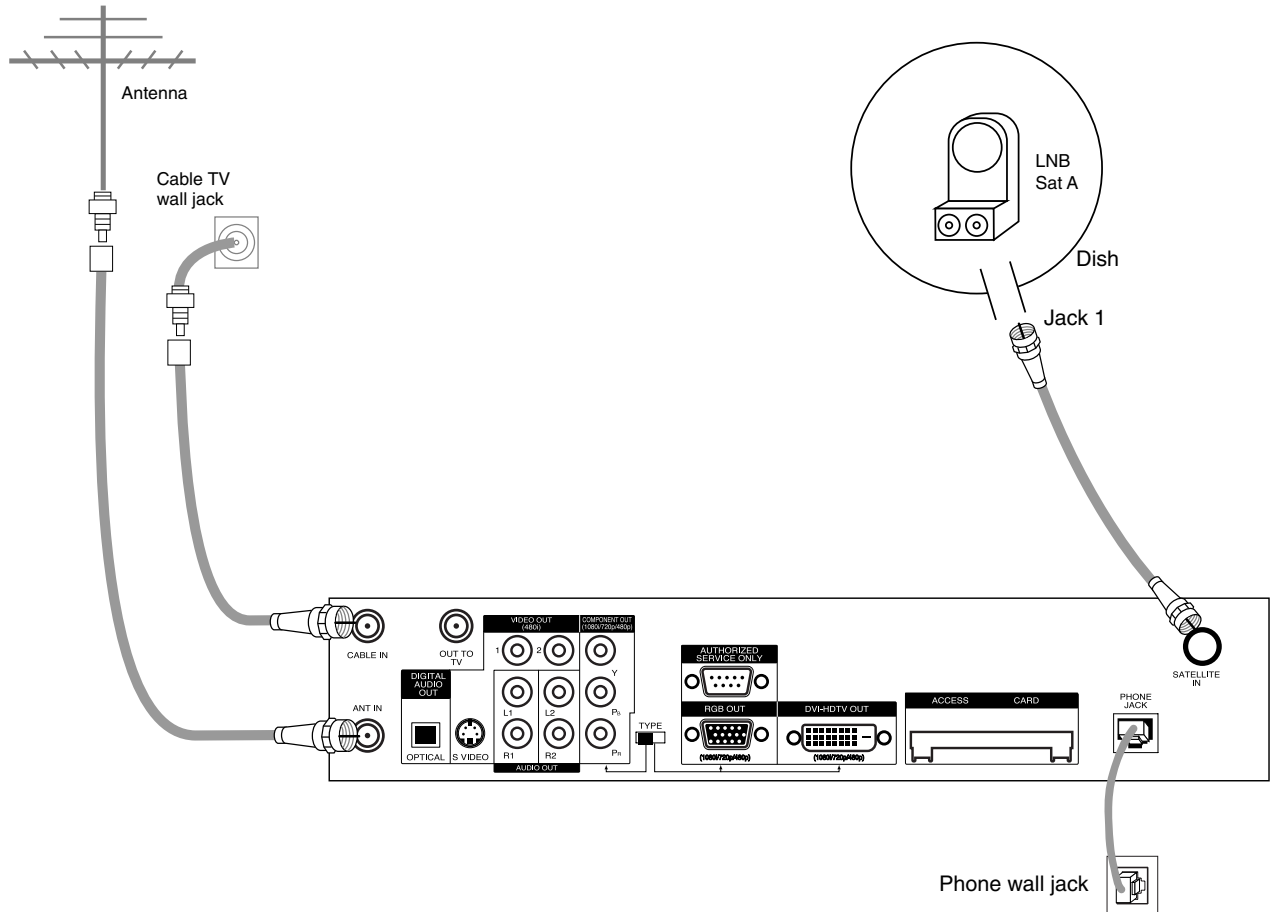

Receiving Signals

1. Connect the "Antenna" to the "ANT IN" jack on the DIRECTV® High-Definition Receiver using a coaxial RF cable.
2. Connect the cable TV signal to the "CABLE IN" jack on the DIRECTV HD Receiver using a coaxial RF cable.
3. Connect the "Jack 1" of the dish antenna to the "SATELLITE IN" jack on the DIRECTV HD Receiver using a coaxial RF cable. (For proper dish installation, refer to the "Installer's Guide" provided with your satellite dish antenna.)
4. Connect the "Phone Wall Jack" to "PHONE JACK" on the DIRECTV HD Receiver using a phone cable.

NOTE

While you are subscribing to a DIRECTV® programming package, you can still view over-the-air and cable TV programs, if you make connections to the over-the-air and/or cable jacks.

NOTE

You may not be able to receive DIRECTV® High-Definition programming with a round dish. A triple LNB multi-satellite dish antenna with a SAT C LNB is required, along with this DIRECTV HD Receiver and high-definition television equipment.

3. SETUP AND CONNECTIONS

3-4. Connecting to Antennas - Oval Dish (Satellite A, B)

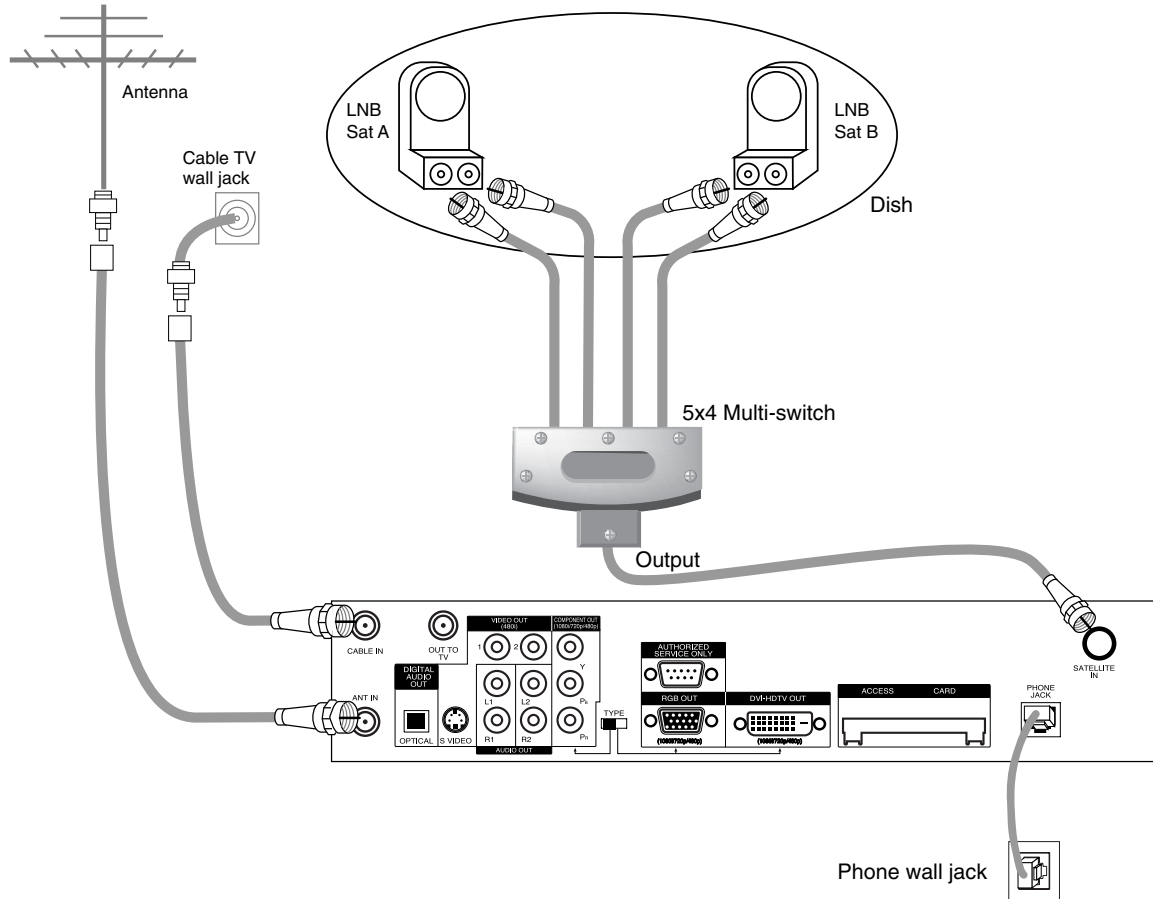

Receiving Signals

1. Connect the "Antenna" to the "ANT IN" jack on the DIRECTV® High-Definition Receiver using a coaxial RF cable.
2. Connect the cable TV signal to the "CABLE IN" jack on the DIRECTV HD Receiver using a coaxial RF cable.
3. Connect the "Jack 1" of the multi-switch to the "SATELLITE IN" jack on the DIRECTV HD Receiver using a coaxial RF cable. (For proper dish installation, refer to the "Installer's Guide" provided with your satellite dish antenna.)
4. Connect the "Phone Wall Jack" to "PHONE JACK" on the DIRECTV HD Receiver using a phone cable.

NOTE

While you are subscribing to a DIRECTV® programming package, you can still view over-the-air and cable TV programs, if you make connections to the over-the-air and/or cable jacks.

NOTE

For access to all DIRECTV® High-Definition programming, a triple LNB multi-satellite dish antenna with a SAT C LNB is required, along with this DIRECTV HD Receiver and high-definition television equipment.

3-4. Connecting to Antennas - Oval Dish (Satellite A, B, C)

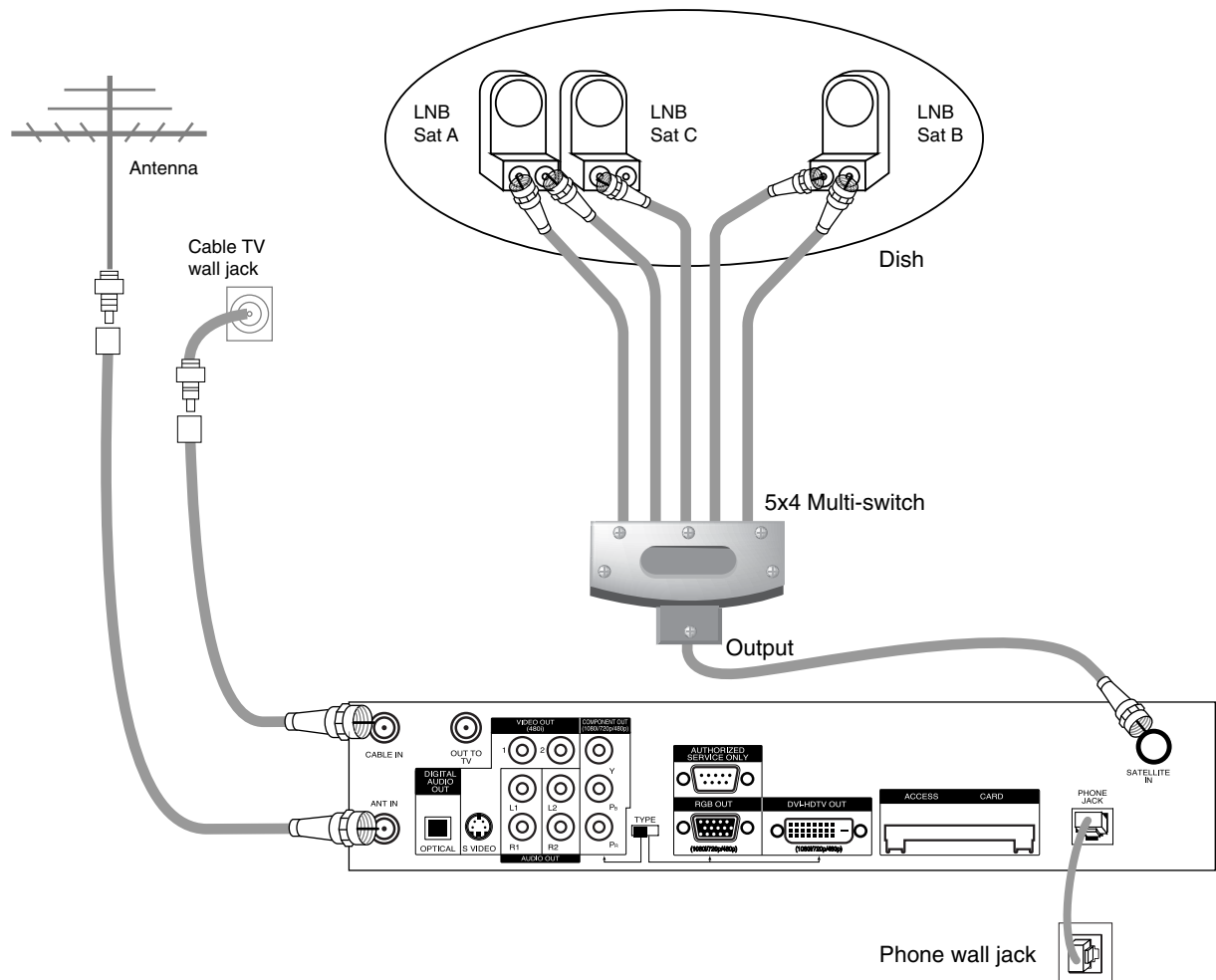

Receiving Signals

1. Connect the "Antenna" to the "ANT IN" jack on the DIRECTV® High-Definition Receiver using a coaxial RF cable.
2. Connect the cable TV signal to the "CABLE IN" jack on the DIRECTV HD Receiver using a coaxial RF cable.
3. Connect the "Jack 1" of the multi-switch to the "SATELLITE IN" jack on the DIRECTV HD Receiver using a coaxial RF cable. (For proper dish installation, refer to the "Installer's Guide" provided with your satellite dish antenna.)
4. Connect the "Phone Wall Jack" to "PHONE JACK" on the DIRECTV HD Receiver using a phone cable.

NOTE

While you are subscribing to a DIRECTV® programming package, you can still view over-the-air and cable TV programs, if you make connections to the over-the-air and/or cable jacks.

NOTE

For access to all DIRECTV® High-Definition programming, a triple LNB multi-satellite dish antenna with a SAT C LNB is required, along with this DIRECTV HD Receiver and high-definition television equipment.

3. SETUP AND CONNECTIONS

3-5. TV Connection - Analog TV

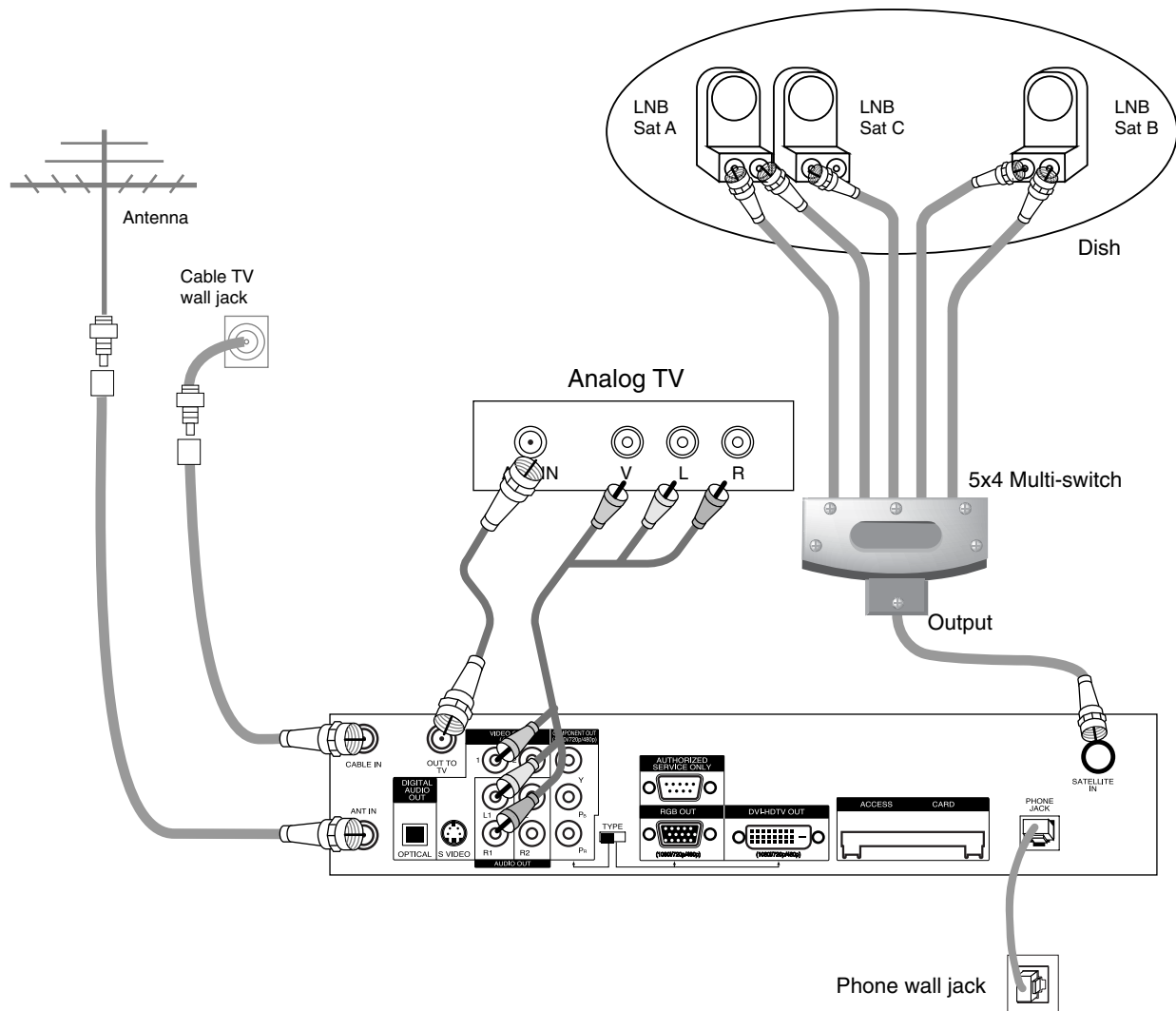

TV Viewing

1. Connect the "OUT TO TV" jack on the DIRECTV® High-Definition Receiver to the "ANT IN" jack on your TV using a coaxial RF cable.
2. Connect the "AUDIO OUT" and "VIDEO OUT" jacks on the DIRECTV HD Receiver to the "A/V IN" jack on your TV using RCA-type cables.

(Note : These connections are only available when video 1/2(480i) display format is selected.)

3-5. TV Connection - HD Monitor (Y/PB/PR type)

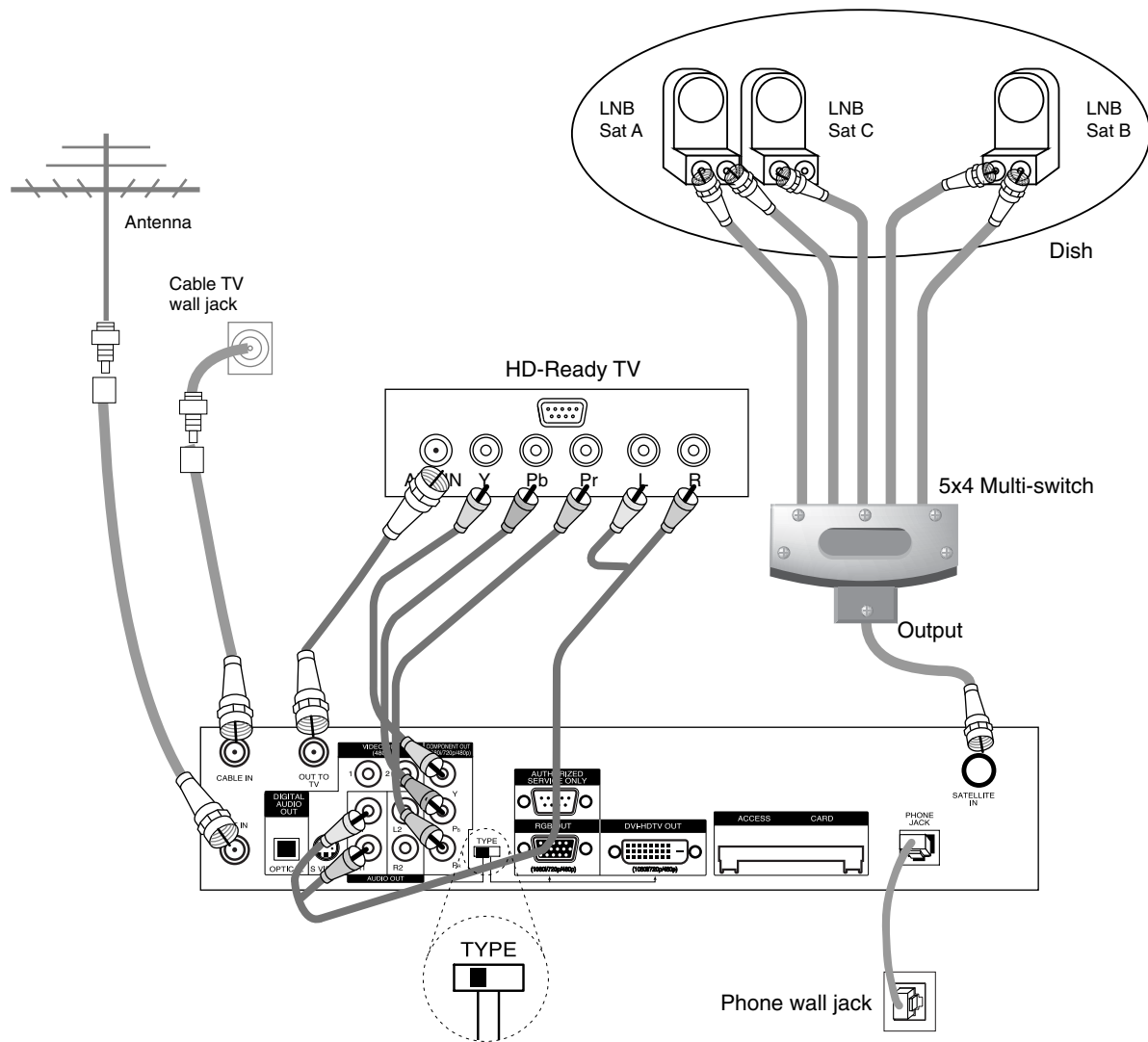

TV Viewing

1. Connect the "OUT TO TV" jack on the DIRECTV® High-Definition Receiver to the "ANT IN" jack on your TV using a coaxial RF cable.
2. Connect the "COMPONENT OUT" jacks on the DIRECTV HD Receiver to the "COMPONENT IN" jacks of your TV using RCA-type cables. (The "TYPE" switch must be set toward the "Y/PB/PR" jacks.)
3. Connect the L/R "AUDIO OUT" jacks on the DIRECTV HD Receiver to the L/R "AUDIO IN" jacks on your TV using RCA-type cables.

(Note : The component out jacks are available when 480p, 720p, or 1080i display format is selected.)

3. SETUP AND CONNECTIONS

3-5. TV Connection - HD Monitor (RGB type)

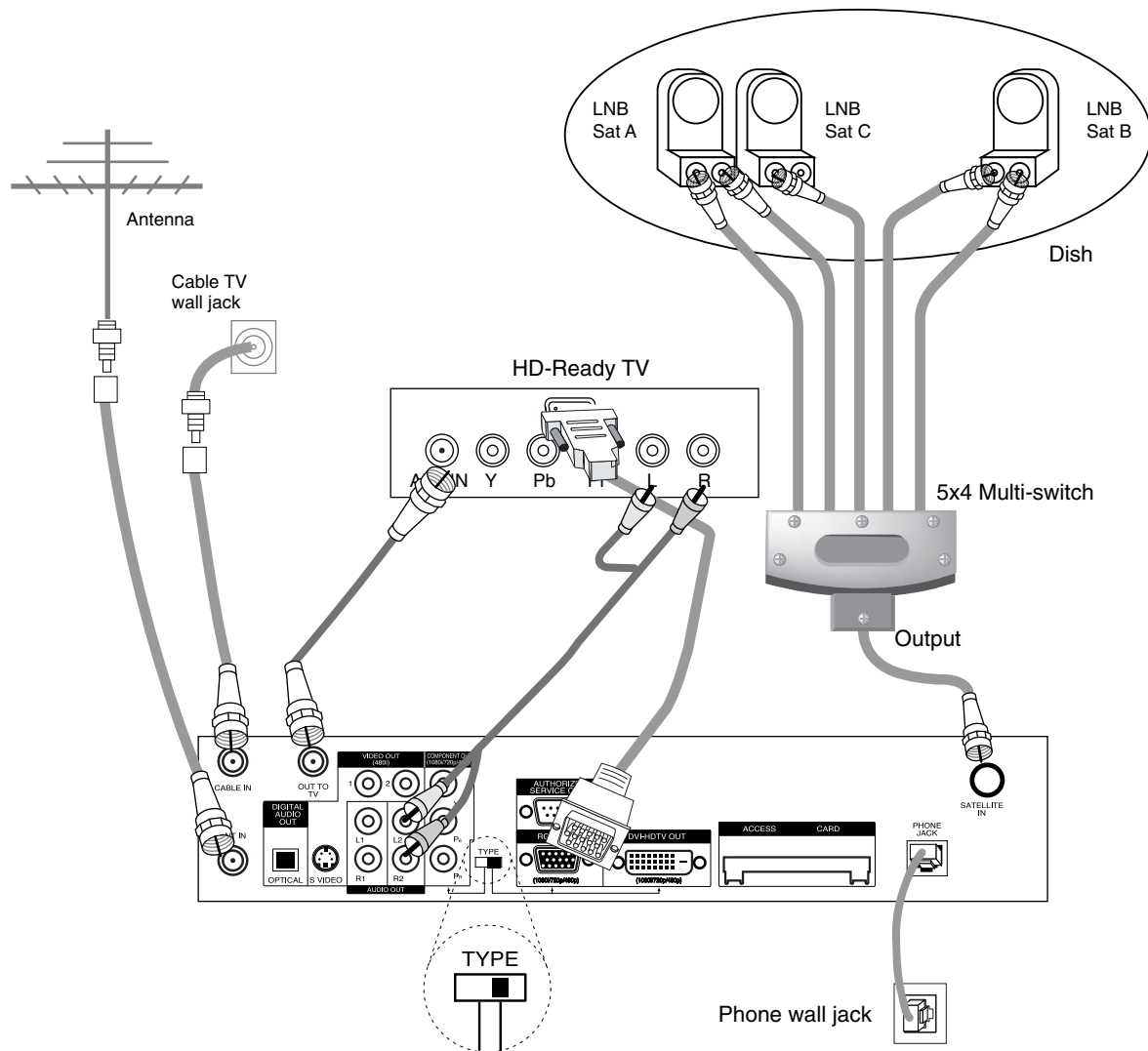

TV Viewing

1. Connect the "OUT TO TV" jack on the DIRECTV® High-Definition Receiver to the "ANT IN" jack on your TV using a coaxial RF cable.
2. Connect the "RGB OUT" jack on the DIRECTV HD Receiver to the "RGB IN" jack of your TV using VGA-type connector. (The "TYPE" switch must be set toward the "RGB/DVI-HDTV" jacks.)
3. Connect the L/R "AUDIO OUT" jacks on the DIRECTV HD Receiver to the L/R "AUDIO IN" jacks on your TV using RCA-type cables.

(Note : The RGB OUT jack is available when 480p, 720p, or 1080i display format is selected.)

3-5. TV Connection - HD Monitor (DVI-HDTV type)

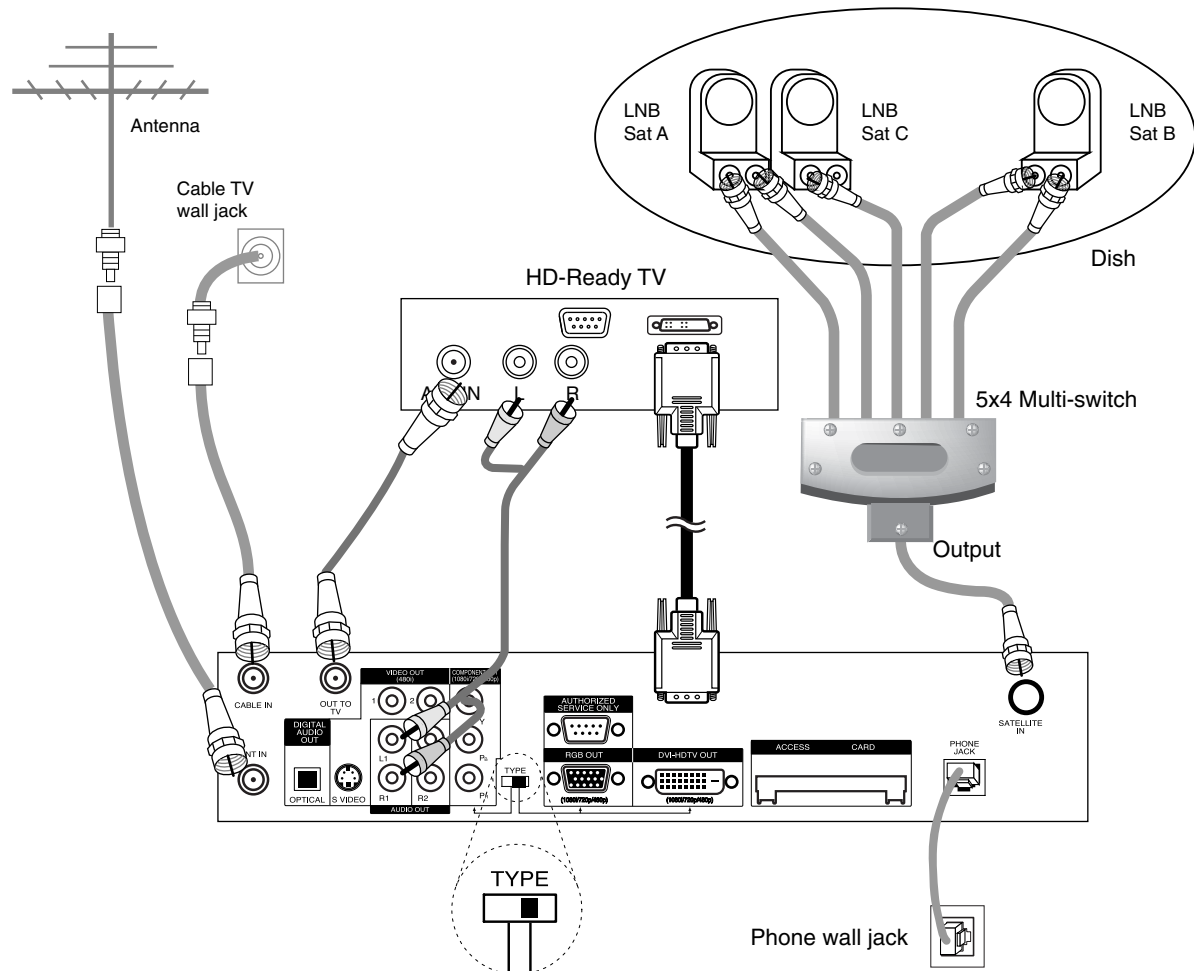

TV Viewing

1. Connect the "OUT TO TV" jack on the DIRECTV® High-Definition Receiver to the "ANT IN" jack on your TV using a coaxial RF cable.
2. Connect the "DVI-HDTV OUT" jack on the DIRECTV HD Receiver to the "DVI-HDTV IN" jack of your TV using DVI -type connector. (The "TYPE" switch must be set toward the "RGB/DVI-HDTV" jacks.)
3. Connect the L/R "AUDIO OUT" jacks on the DIRECTV HD Receiver to the L/R "AUDIO IN" jacks on your TV using RCA-type cables.

(Note : The DVI-HDTV OUT jack is available when 480p, 720p, or 1080i display format is selected.)

Note: For best access to high-definition and programming from DIRECTV, connect the DVI-HDTV output to a DVI-HDTV input on your high-definition TV or monitor. A DVI-HDTV input is one that is compliant with EIA-861 and HDCP specifications. Check your TV or monitor's user manual to find out if the TV or monitor's DVI input is compliant with these specifications.

3. SETUP AND CONNECTIONS

3-6. VCR Connection

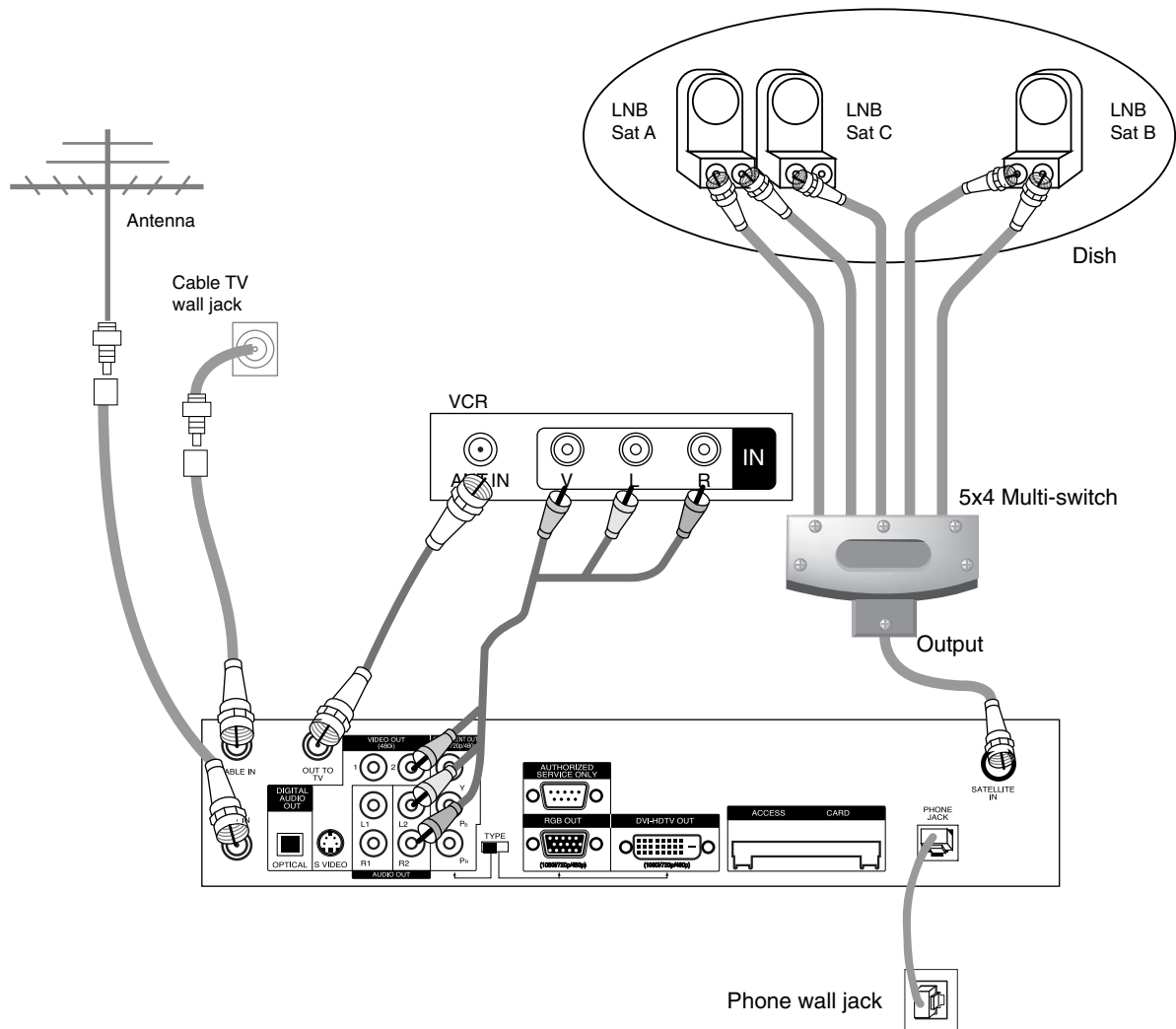

TV Viewing

Refer to Section 3.5, 'TV Connection'.

VCR Recording

1. Connect the "OUT TO TV" jack on the DIRECTV® High-Definition Receiver to the "ANT IN" jack on your VCR using a coaxial RF cable.
2. Connect the "AUDIO OUT" and "VIDEO OUT" jacks on the DIRECTV HD Receiver to the "A/V IN" jack on your VCR using a RCA-type cable. (If your VCR is equipped with an S-Video jack, use the "S-Video" jack)

(Note: The OUT TO TV and VIDEO OUT 1 / 2 jacks are available when the Video 1/2 display format is selected)

3-7. Audio Connection - Digital Audio System

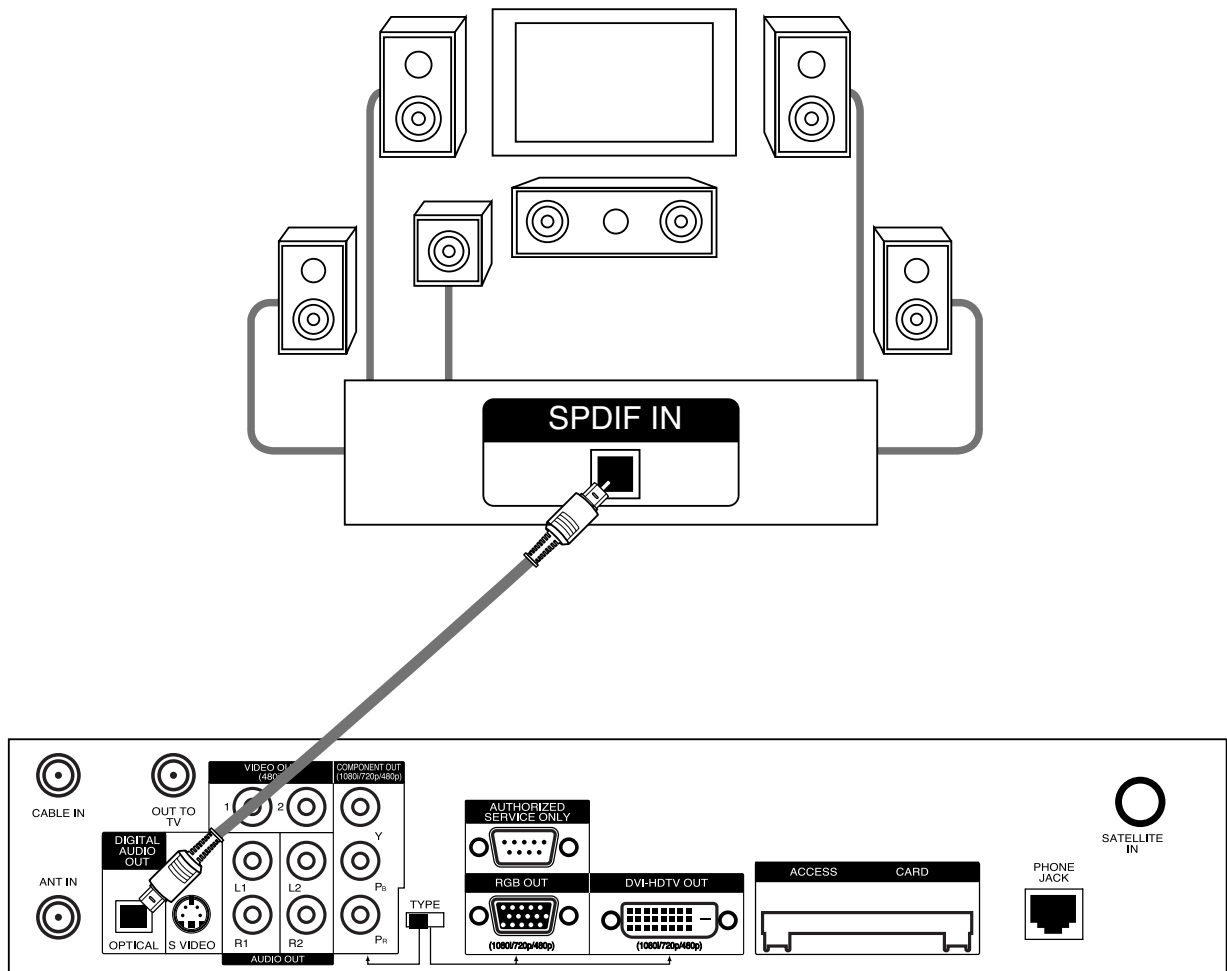

Dolby AC-3 Connection

1. Connect the "DIGITAL AUDIO OUT" jack on the DIRECTV® High-Definition Receiver to the "SPDIF IN" jack on your Dolby Digital or Pro Logic decoder using a digital optical cable. (A digital optical cable is not supplied.)

3. SETUP AND CONNECTIONS

3-7. Audio connection - Analog Hi-Fi System

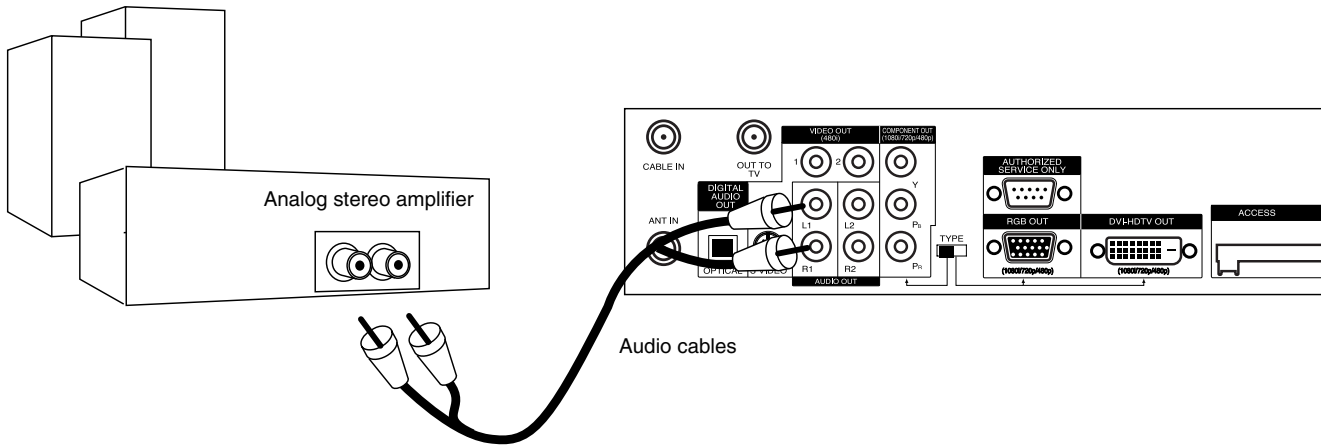

Hi-Fi System Connection

1. Connect the Left and Right "AUDIO OUT" jacks of the DIRECTV® High-Definition Receiver to the Left and Right "INPUT" jacks on your Hi-Fi audio system.

4. FRONT PANEL AND REMOTE CONTROL

4-1. Using the Front Panel of the DIRECTV® High-Definition Receiver



1 Power

Turns the DIRECTV HD Receiver on or off.

2 Display Window

Shows DIRECTV HD Receiver status : Current output format, output type, and channel number.

3 Remote Control Sensor

Receives signals from the remote control.

4 Format

Sets the output resolution to one of 1080i, 720p, 480p, video 1/2, variable 1, variable 2, variable 3, and Auto DVI formats. Choose the correct display format for your TV. (Refer to Section 2.3, 'Display Formats')

5 Display

Shows station and program information in the banner shown at the top of the screen. To remove the banner, press the button again or wait for 10 seconds. You can select the display mode, short or detailed, by pressing "▲▼". You can also change the Audio language, when available, by pressing "◀▶".

6 Menu

Shows the main menu on the screen. You can return to normal viewing by pressing the **Exit** button.

7 Guide

Shows the DIRECTV Advanced Program Guide™ screen that shows you a program schedule containing a list of current and future programs. You can also access the Advanced Program Guide™ via the main menu (DIRECTV Guide). You can return to normal viewing by pressing the **Exit** button.

8 Select

If the main menu is displayed, pressing the **Select** button will activate the selected MENU item. If the **Select** button is pressed while you are in normal viewing, the information banner will be displayed.

9 Exit

Clears all on-screen displays and returns to normal viewing from any menu.

10 Arrow Key (CH +/-)

Allows you to navigate on-screen menus and to adjust the system settings and preferences. Use the arrow keys to move to a menu option and then use the **Select** button to access it.

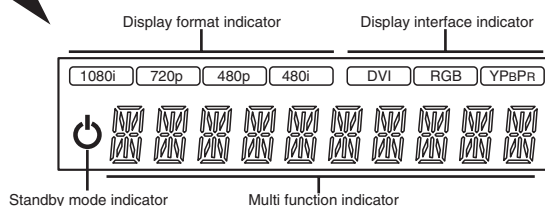

4. FRONT PANEL AND REMOTE CONTROL

4-2. Using the Remote Control

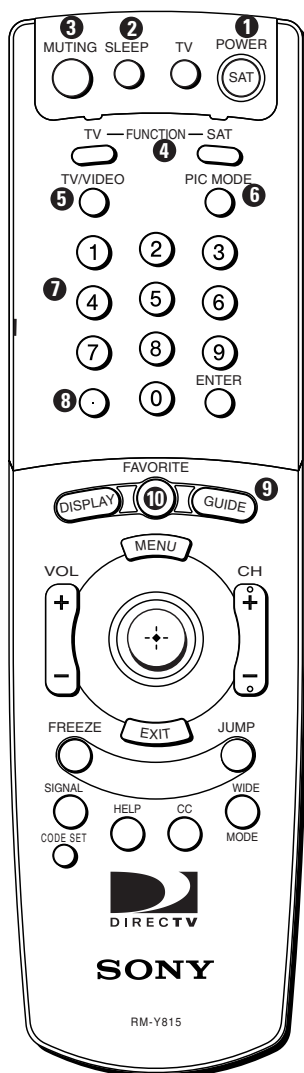

1 POWER buttons

Turn on and off the DIRECTV® High-Definition Receiver and TV. To operate your TV, you may need to first set up the remote control (see page 38).

2 SLEEP button

Sets the TV to turn off automatically after a certain amount of time (if your TV has a compatible Sleep feature). To operate your TV, you may need to first set up the remote control (see page 38.)

3 MUTING button

Mutes the TV volume. Press again to restore the volume. To operate your TV, you may need to first set up the remote control (see page 38.)

4 FUNCTION buttons

Select the equipment (TV or SAT) that you want to operate. The indicators light up to show which device the remote control is operating. To operate your TV, you may need to first set up the remote control (see page 38.)

5 TV/VIDEO button

Switches between the various inputs of your TV. To operate your TV, you may need to first set up the remote control (see page 38.)

6 PIC MODE button

Switches between the Picture Mode settings of compatible TVs. To operate your TV, you may need to first set up the remote control (see page 38.)

7 0-9 and ENTER buttons

Change channels directly and enter numerical values in on-screen displays.

8 • (dot) button

Use with the 0-9 and ENTER buttons to select subchannels (for example, 2.1, if available).

9 GUIDE button

Opens the Program Guide.

10 FAVORITE button

Opens the Favorite List.

4-2. Using the Remote Control

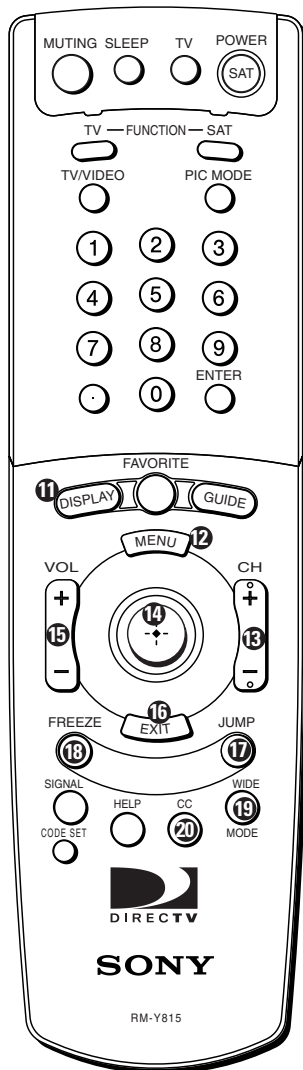

11 DISPLAY button

Opens the program information display for the current program.

12 MENU button

Opens the main Menu.

13 CH (channel) +/- buttons

Changes channels. When a program guide is open, pressing the CH button pages through the guide.

14 Joystick

Moving the joystick up, down, left and right moves the highlight in on-screen displays. Press the joystick to select the highlighted item.

15 VOL (volume) +/- buttons

Adjust the volume of your TV. To operate your TV, you may need to first set up the remote control (see page 38.)

16 EXIT button

Closes on-screen displays.

17 JUMP button

Changes channels to the previously tuned channel.

18 FREEZE button

Freezes the current picture. Press again to restore the live picture.

19 WIDE MODE button

Changes the aspect ratio options of the DIRECTV® High-Definition Receiver. When you view a picture with a wide (16:9) aspect ratio in 480i or 480p format, the button changes the WIDE MODE options to Letterbox, Cropped or Squeezed. When you view a picture with a standard (4:3) aspect ratio in 720p or 1080i format, the button changes the WIDE MODE options to Normal, Wide, Panorama, Zoom 1 or Zoom 2.

Detailed descriptions of WIDE MODE options are given in section 2.4 or in the WIDE MODE section of the Preferences menu.

20 CC (Closed Caption) button

Changes the Closed Caption options of the DIRECTV HD Receiver. The closed caption mode can be selected in the Closed Caption section of the Preferences menu. You can also change the date of the Advanced Program Guide by pressing the CC button when the Guide is displayed.

4. FRONT PANEL AND REMOTE CONTROL

4-2. Using the Remote Control

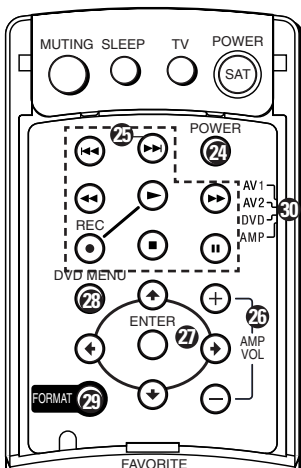
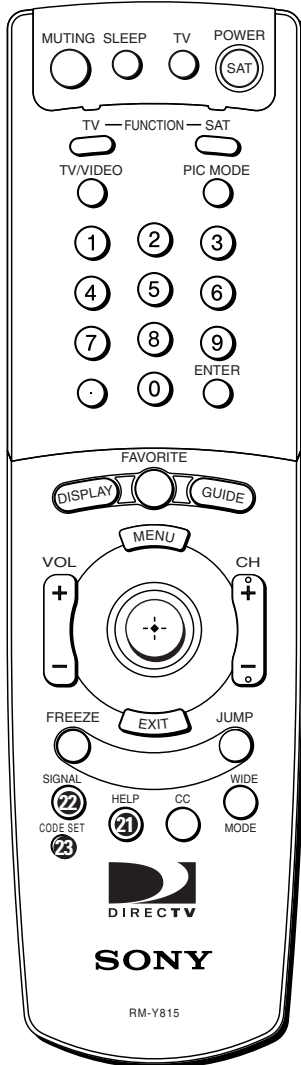

- 21 HELP button**
 Opens the on-screen Help menu when no on-screen displays are open. You can also see the help description of a menu item when that menu is open by pressing and holding the HELP button.
- 22 SIGNAL button**
 Shows the signal strength of the current digital over-the-air channel or satellite channel. The signal strength may be improved by adjusting the over-the-air antenna or satellite dish antenna as directed by the antenna installation instructions.
- 23 CODE SET button**
 Lets you program the remote control to operate your TV and other audio/video equipment (see page 38).
- 24 POWER button**
 Turns on and off other devices in your home theater selected with the AV1/AV2/DVD/AMP switch. To operate other home theater devices, you may need to first set up the remote control (see page 38).
- 25 VCR/DVD control buttons**
 Operate VCR and DVD functions such as play, pause, stop, fast wind, rewind and record. To operate your VCR or DVD player, you may need to first set up the remote control (see page 38).
- 26 AMP VOL (amplifier volume) +/- buttons**
 Adjust the volume of your audio receiver. To operate your audio receiver, you may need to first set up the remote control (see page 38).
- 27 DVD navigation and select buttons**
 Let you highlight and select items in DVD menus. To operate your DVD player, you may need to first set up the remote control (see page 38).
- 28 DVD MENU button**
 Opens the menu system of the current DVD. To operate your DVD player, you may need to first set up the remote control (see page 38).
- 29 FORMAT button**
 Changes the video format that is output from the DIRECTV® High-Definition Receiver. Depending on the type of monitor that the DIRECTV HD Receiver is connected to, the available formats may include : video 1/2, 480p, 720p, 1080i, variable 1, variable 2, variable 3 and Auto DVI.
- 30 AV1/AV2/DVD/AMP switch**
 Sets the remote to operate other devices in your home theater. To operate other home theater devices, you may need to first set up the remote control (see page 38).

4-3. Programming THE REMOTE CONTROL

The RM-Y815 remote control is a universal remote control that can be programmed to control most TV, VCR, DVD and Amp models of the brands that appear on pages 39-40.

1. Find the code(s) for the brand of the device you want to operate with this remote control.

You can find these codes on pages 39-40.

2. Press the CODE SET button.

The function indicator begins flashing.

3. Press the 0-9 buttons to input the brand code, then press the ENTER button.

The function indicator goes off, and the remote is set up to operate that device.

4. Test the remote control.

Press the POWER button for that equipment, then press other operation controls such as the CH+/-buttons. If the device does not respond to the remote control, repeat from step 2 and enter a different brand code in step 3.

4. FRONT PANEL AND REMOTE CONTROL

4-4. Remote Control Codes for Other Components

TV Codes

Manufacturer	Code
Sony	101
Admiral (M. Wards)	102, 114, 109
ABC	112
Bell & Howell (M. Wards)	114, 109, 138
Broksonic	103, 112
Craig	122, 123, 120, 121
Croslex	111
Curtis Mathis	103, 119, 123
Daewoo	135, 136, 103
Daytron	116 143
Dynasty	113
Emerson	122, 113, 120, 121, 123, 103, 115
Fisher	125
General Electric	102, 118, 103, 107
Goldstar	103, 113, 112, 130
Hitachi	131, 113, 103, 132
JCPenny	103, 102, 130, 107
JVC	128, 129
KTV	133, 113, 103, 123, 134
Loewe	111
LXI (Sears)	102, 103, 111, 125, 119, 112
Magnavox	111, 112, 113, 107
Mitsubishi/MGA	124, 103, 112
NEC	103, 112
Panasonic	118, 116, 117, 107
Philco	111, 118, 109
Philips	111
Pilot	103
Pioneer	137, 118, 119
Portland	103, 108
Quasar	110, 107
Radio Shack	102, 112, 124, 123
RCA/Proscan	102, 103, 104, 105, 106, 107, 108
Samsung	126, 112, 113, 103
Sanyo	125
Scott	123, 112
Sharp	114, 113, 115
Singnature 2000 (M. Wards)	114, 109
Sylvania	111, 112, 108
Symphonic	123, 139
Technika	109
Toshiba	119, 114
Vidtech	131, 103, 112
Wards	113, 103, 115, 112
Zenith	108, 110

VCR Codes

Manufacturer	Code
Sony	301, 302, 303
Aiwa	338
Audio Dynamics	314, 347
Bell & Howell (M. Wards)	330, 343
Broksonic	317, 319
Canon	309, 308
Citizen	332
Curtis Mathis	304, 338, 309
Daewoo	341, 312, 309
DBX	314, 336, 337
Dimensia	304
Emerson	319, 320, 316, 317, 318, 341
Fisher	330, 334, 335, 333
Funai	338
General Electric	329, 304, 309
Go Video	322, 339, 340
Goldstar	332
Hitachi	306, 304, 305, 338
HQ	315
Instant Replay	309, 308
JCPenny	309, 305, 304, 330, 314, 336, 337
JVC	314, 336, 337
Kenwood	314, 336, 332, 337
LXI (Sears)	323, 305, 333, 334, 330, 335, 338
Magnavox	310, 308, 309
Marantz	314, 336, 337
Marta	332
Memorex	309, 335
Minolta	305, 304
Minolta	305, 304
Mitsubishi/MGA	323, 324, 325, 326
Multitech	325, 338, 321
NEC	314, 336, 337
Olympic	309, 308
Optimus	327
Panasonic	308, 309, 306, 307
Pentax	305, 304
Philco	308, 309
Philips	310, 308, 309
Pioneer	308
Quasar	306, 308, 309
RCAProscan	309, 305, 308, 309, 310, 311, 312, 313

4-4. Remote Control Codes for Other Components

VCR Codes (Continued)

Manufacturer	Code
Realistic	309, 330, 328, 324, 338
Sansui	314
Singer	315
Samsung	322, 313, 321
Sanyo	330, 335
Scott	312, 313, 321, 335, 323, 324, 325, 326
Sharp	327, 325, 328
Shintom	315
Signature 2000 (M. Wards)	336, 327
Sylvania	310, 308, 309, 338
Symphonic	338
Tashiro	332
Tatung	314, 336, 337
Teac	314, 336, 338, 337
Technics	309, 308
Teknika	338, 342
Toshiba	312, 311
Wards	327, 328, 335, 331, 332
Yamaha	330, 314, 336, 336, 337
Zenith	331

AMP (Amplifier) Codes

Manufacturer	Code
Sony	501
Denon (Sharp)	516, 517, 518
Harmon	519
JVC	506, 507, 508
Kenwood	504, 505
McIntosh	520
Onkyo	512, 513
Pioneer	502, 503
Technics	509, 510, 511
Yamaha	514, 515

DVD Codes

Manufacturer	Code
Sony	601
Panasonic	604
Pioneer	605
RCA	602
Toshiba	603

IMPORTANT: Check your TV screen to determine the format required. The format must be set to appropriate mode using format button on the front panel. The on screen display or the picture may not appear if the wrong format mode is selected.

When you turn on the DIRECTV® High-Definition Receiver for the first time, you will be asked if you want to set up DIRECTV® programming.

If you have chosen to subscribe to DIRECTV programming (or service), you should initialize the system according to section 8-6.

If you don't have any dish, you should select "NO". This means you can receive only off-air broadcast (analog & digital).

This setup process will be displayed only once. This means that you can change your selection at any time in the future using the DIRECTV Initial setup menu.

If you have chosen to subscribe to DIRECTV programming, you should contact DIRECTV at 1-800-DIRECTV (or 1-800-347-3288) and order programming.

When you order programming, you need to know your access card number. To get this number, press **MENU** on the remote control, then select SYSTEM on the Menu. Select System Test on the screen, and you will see the Access Card Identifier. Another way to find the number is by taking out the access card and referring to the number written on it.



6. BASIC OPERATION

6-1. Viewing the Channel Banner

The Channel Banner appears whenever you tune to a new channel or press the **Display** button on the remote control while viewing a program. It displays channel and program information in the banner shown at the top of the screen. When the Channel Banner is displayed, pressing “▲▼” toggles between extended and regular information banners. To remove the banner, press **Display** again or wait for 10 seconds.

The icons in the Channel Banner represent the status or availability of important features. The icons will be highlighted when the feature is active or available as provided by the broadcaster and service provider. The information available on the Channel Banner is described below.

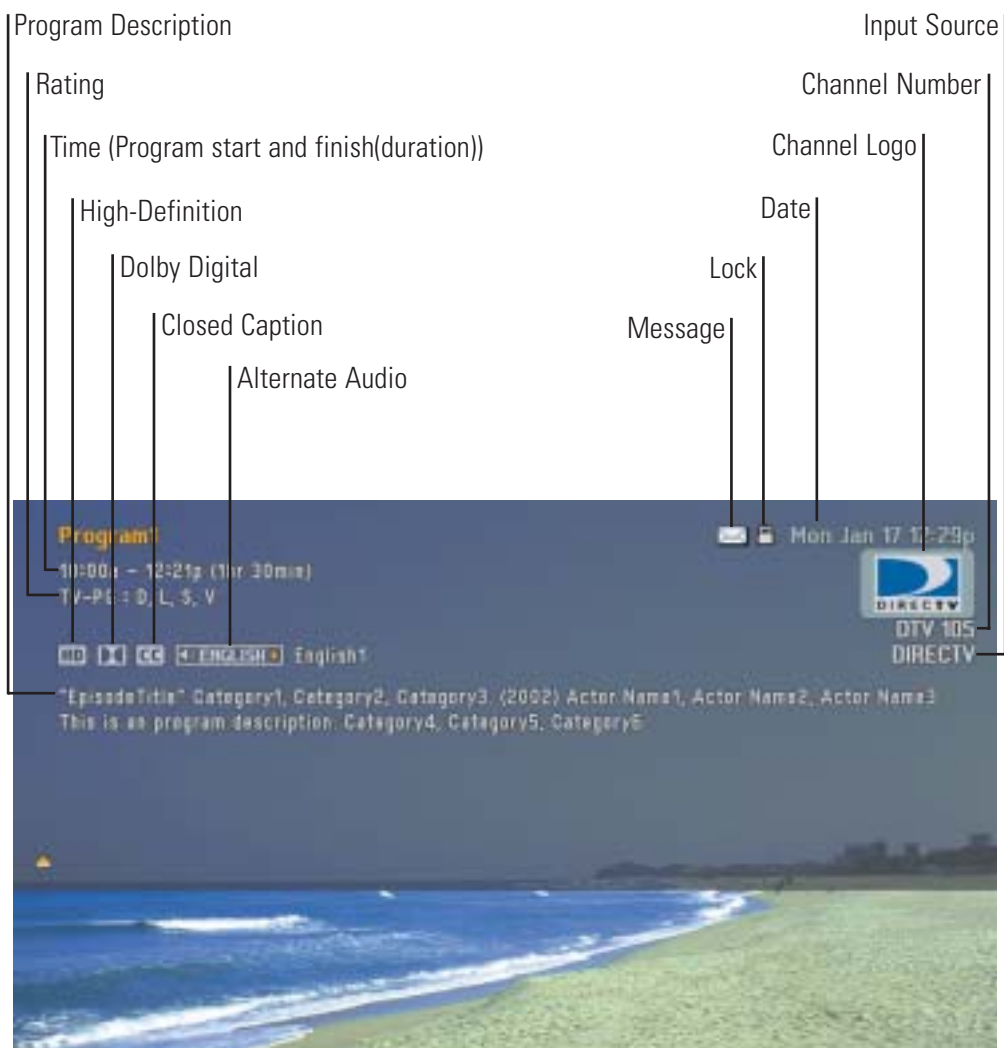

6. BASIC OPERATION

6-1. Viewing the Channel Banner

Input Source Icon (DIRECTV)

Indicates from which source the current program signal is being received. The DIRECTV® High-Definition Receiver can receive a signal from ANT, ANT/Digital, CABLE or DIRECTV.

Lock Icon ()

Indicates that the lock system is activated.

Alternate Audio (ENGLISH)

DIRECTV and ATSC channels sometimes provide multiple audio tracks, usually in different language. When multiple audio tracks are available, the Alternate Audio icon changes its appearance to indicate that you can select one of those audios by pressing “◀▶” buttons.

Message Icon ()

Indicates that your DIRECTV HD Receiver has messages from DIRECTV. The message icon will appear in the channel banner to indicate that a new message has arrived or there are unread messages in the box.

HD Icon ()

Indicates that the current program is in the HD format.

DD Icon ()

Indicates that the currently selected audio track is Dolby Digital.

CC Icon ()

Indicates that the current program provides the closed caption service.

Channel Logo

Displays the logo of the current channel. If a channel logo is not available, the channel name will be displayed instead.

Channel Number

Displays the current channel number.

Start and End Time

Displays the start time and end time of the current program.

Rating

Displays the rating of the current program.

Date

Displays the current date and time.

Program Description

Displays a brief description of the current program (if available).

Category

Displays the genre of the current program.

6-2. Surfing Favorite Channels

The favorite list appears on the TV screen when you press the **Favorite** button on the remote control. It enables you to surf up to 50 favorite channels that were chosen in the Edit Channel section of the Setup menu. The favorite list consists of the channel logos or channel numbers. If the logo of a certain channel is not available, the channel number is displayed instead.

You can easily move the highlight on the favorite list using “▲▼◀▶” on the remote control. The next page is accessible by using **CH +/-** button on the remote. You can tune to a favorite channel by pressing “↵”. Or the **Exit** button on the remote will clear the favorite list and take you back to the current channel.

You are also able to add or delete the logo of a channel on the favorite list by pressing the **Display** button on the remote. A dialog box will ask what you want to do with the highlighted logo area: you can replace the highlighted logo area with the current channel, or delete it.

6. BASIC OPERATION

6-3. Subscription to DIRECTV® programming and ANT/CABLE-Only operation

The DIRECTV® High-Definition Receiver is designed to receive signals from DIRECTV, ANT and /or CABLE. If you are a DIRECTV customer, you can enjoy programming provided by DIRECTV.

You can also receive the analog and digital over-the-air broadcasts, with the benefit of the Advanced Program Guide™ (APG) which is an integrated electronic program guide. The APG provides program listings and information on analog and digital channels from over-the-air local stations as well as DIRECTV channels. You can easily navigate and tune to hundreds of channels from various signal sources with the APG.

If you don't subscribe to DIRECTV® programming, however, the function of the DIRECTV HD Receiver will be limited to receiving signals only from ANT and/or CABLE. You can still enjoy HD services provided by over-the-air digital broadcast along with the conventional analog broadcast. Without the DIRECTV service, however, no electronic program guide is available.

7. ADVANCED PROGRAM GUIDE™

7-1. About the Advanced Program Guide™

The DIRECTV Advanced Program Guide™ contains schedule and program information for all DIRECTV® channels. The APG also provides local over-the-air channels information including both conventional analog and digital channels if you receive satellite service.

Helping you to find a program easily and conveniently, the APG allows you to view schedule and descriptive program information for the channels. The receiver offers five different channel lists: ALL, CUSTOM, FAVORITE, MOVIES and SPORTS. You may edit the CUSTOM and FAVORITE channel lists to customize and design your favorite channels, respectively. In addition, you can easily find specific programs by using the CATEGORY search of KEYWORD search functions. An explanation of each channel list is described in Section 7-2.

You can bring up the APG in two ways and exit from it in three ways.

To bring up the APG:

- Press the **Guide** button on your remote control.
- or
- Press the **Menu** button on the remote control and select the DIRECTV menu. Several options will appear. Choose the Guide option (MENU → DIRECTV → Guide)

To exit the APG:

- Press the **Exit** button to return to the last channel you were tuned to.
- or
- Press the **Guide** button on the remote control twice when a program or channel is highlighted. The first press moves the highlight to the Guide menu at the far left. Pressing the button a second time makes the APG disappear.
- or
- When any currently broadcasted program is highlighted, pressing “↵” will make the guide screen disappear and tune to that channel.

7. ADVANCED PROGRAM GUIDE™

7-2. Layout of the Advanced Program Guide™ Screen

The on-screen guide maintains five different channel lists, each of which shows you only those channels and programs that belong to that channel list. The meaning and generation of each channel list is described below

- All** Shows program listings for all channels that you are eligible to access. They include DIRECTV® channels that your dish antenna can receive, and over-the-air channels that you have selected to add into the channel list during the initial setup procedure.
- Custom** Shows the program listings that belong to the CUSTOM channel list. You can customize the CUSTOM channel list by hiding channels from the All channel list that you do not wish to view.
- Favorite** Shows program listings only for those channels on the FAVORITE channel list. You can generate a FAVORITE channel list, which is a short list of channels you tune to most frequently, by setting a favorite icon to the channels from the menu sequence MENU → SETUP → Favorite/Ch. Edit.
- Movies** Lists only movie programs from channels in the All channel list that have acceptable ratings. The DIRECTV® High-Definition Receiver generates the list automatically based on the category information of each program identified in the APG.
- Sports** Shows only sports programs. The DIRECTV HD Receiver generates the list automatically based on the category information of each program identified in the APG.

The guide screen also provides two search menus:

- Category** Searches for programs that belong to a given category. The DIRECTV HD Receiver first shows you currently applicable categories and allows you to search for programs in that category.
- Keyword** Searches for programs that have or are related to a specific keyword. You can choose a keyword for program titles or credit titles (for example, actor/actress, director, writer, awards, etc.).

When accessing an on-screen guide, you will always return to the guide menu, one of the five channel lists or one of the two search menus, that you have previously viewed.

7-3. Moving through the Advanced Program Guide™

The Advanced Program Guide™ is operated based on a simple and straightforward “Highlight and Select” process.

1. Use “▲▼◀▶” on your remote control to navigate the guide screen.
2. Press “-+” to select or execute the highlighted menu or function.

The on-screen guide shows you program listings for seven channels within an one and one half hour time slot. For example: 6:00-7:30. In order to view a list of future programs or other channels, you may continuously press “▲▼◀▶” to scroll horizontally or vertically. This may take a while to reach a specific channel or program, if the channel or program is listed far from the currently highlighted program. The Advanced Program Guide™ thus offers you shortcuts to minimize your effort in navigating channels and time slots.

Line Scrolling

You can reach other time slots or channels that are currently hidden from the screen using the arrow buttons “▲▼◀▶”. Move horizontally to reach other time slots and move vertically to reach other channels.

Page Scrolling

You can move faster vertically by scrolling page by page with the **CH +/-** buttons on the remote control. Each button stroke scrolls one page up or down.

Date Scrolling

You can scroll time slots day-by-day using the **CC** button on the remote control. Alternatively, you can move the highlight to the Date Change Box and change the date to jump to the time slot of that day.

Direct Jumping

You can quickly jump to a page that contains a specific channel by directly entering a channel number using the digit buttons “0~9” on the remote control. Pressing “-+” following the digit button strokes will move to the channel immediately.

NOTE

Press the **Guide** button to return immediately to the guide menus, the left-most column of the guide screen. This is very useful when the highlight is located far from the current time and you want to return to the guide menus.

7. ADVANCED PROGRAM GUIDE™

7-4. Selecting a Program

The top region of the guide screen displays the schedule and program information of the currently highlighted program. You can also see other detailed information about the program by pressing the **Display** button.

When you select the highlighted program by pressing “↵”, what happens or appears next depends on whether the highlighted program is currently on-air or scheduled in the future, and whether or not it is a pay per view program.

Current / not PPV

If the selected program is a current free-of-charge program, you will directly tune to the program.

Future / not PPV

If the selected program is scheduled in the future and is not a PPV, you will be offered a dialog box that enables you to reserve this program for watching. If you select Remind in the dialog box, this program is put on the Remind List and you will be reminded by a message at the top-left corner of the screen 10 seconds before its airing time.

Current / DIRECTV® Pay Per View

If the selected program is a current pay per view program, you will be asked if you want to purchase this program.

Future / DIRECTV® Pay Per View

If the selected program is a pay per view program scheduled in the future, you will also be asked if you want to purchase this program. Once you confirm the purchase, this program is put on the Future Purchase list. You can view the Future Purchase list from the menu sequence Menu → DIRECTV → Future Purchase and cancel any purchase on the list anytime before its airing time.

A continuous connection to a land-based phone line is required to perform this function with your remote control.

(Note: Pay per view programs can only be purchased with the 24 hours of the program times.)

7. ADVANCED PROGRAM GUIDE™

7-6. Referring to Help

Your basic understanding of certain features and terminology used in the APG will help you to fully enjoy the functionality of the DIRECTV® High-Definition Receiver. The receiver's unique feature called 'Help' serves as an on-line snapshot user's manual.

If you want to find out what the highlighted menu item is for and how it works while you are in the APG, just press and hold the **"Help"** button on your remote control. A quick help screen with brief and focused descriptions will appear at the right side of the screen. Help also provides operation tips at the bottom of every page.

Once you release the **"Help"** button, the help display will disappear instantly.

If you press the **"Help"** button while you are viewing a program, it will guide you to the Help feature, which is an on-line version of this Operating guide.

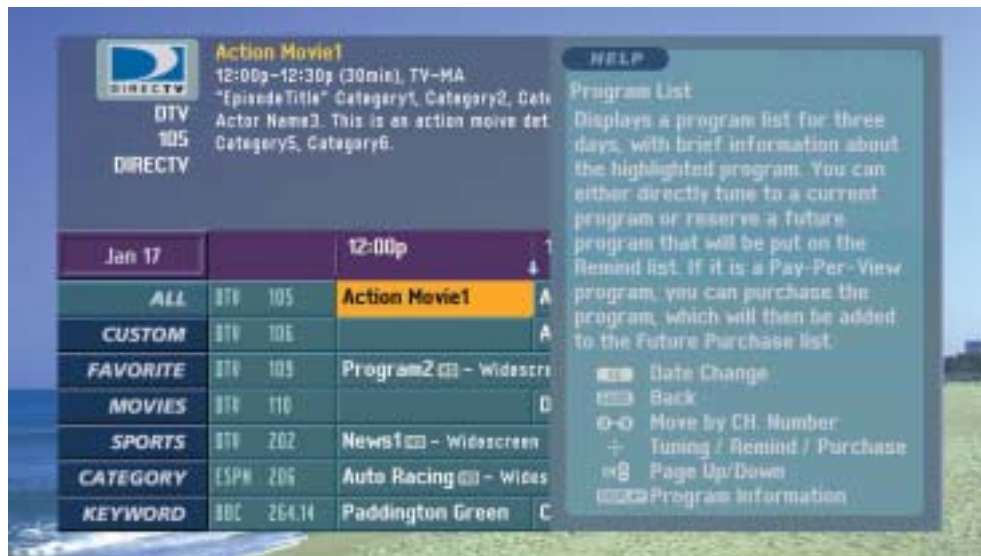

7-7. Making a Remind List for Future Viewing

If you want to view a program scheduled in the future, you can put that program on the Remind List so that a reminder message will appear right before the program starts.

To schedule a future viewing :

1. Move the highlight to a future program you want to watch using “▲▼◀▶” on the remote control.
2. Press “+”. A dialog box will appear for your information.
3. Move the highlight to the Remind option in the dialog box and press “+” to confirm. The program name will be preceded by the mark (√). If you want to cancel any reservation, execute the menu sequence MENU → DIRECTV → Remind List and press “+” when the highlight is on the reservation.



NOTE

A reminder message will appear at the top-left corner of the screen 10 seconds before the reserved program actually starts. The receiver will automatically tune to the program if you do not cancel it.

Pay per view programs can only be purchased with the 24 hours of the program times.

7. ADVANCED PROGRAM GUIDE™

7-8. Purchasing DIRECTV® Pay Per View Programs

If you subscribe to DIRECTV® programming, you may preview pay per view movies on channel 200, the DIRECTV promo channel, to determine if you would like to purchase them.

To purchase PPV programs:

1. From the program guide, press “+” on the remote control to select the PPV program.
A dialog box will appear to ask you whether you want to purchase or not.
Selecting the “Others” button will show you other time schedules for the program.
2. Move the highlight to the right to “Buy” in the dialog box and press “+”.
Another pop-up box will be displayed to verify your purchase.
3. If the price to record the program is different, a Record button will appear. Move the highlight to the right again to “Record” in the dialog box and press “+”.
The program may be recorded via Audio Out and Video Out 1 or 2 if the Format is set to video 1/2.
A continuous connection to a land based phone line is required to order PPV with your remote control.
(Note: Pay per view programs can only be purchased with the 24 hours of the program times.)



7-9. Searching Programs by Category

You can search for specific programs by their categories. The category information of each program is provided by the APG so that you can choose one of them to search for matching programs. You can also set a search range to One Day or Three Days, (within 24 hours and 72 hours from now, respectively). In the search result one program may have multiple showings in different channels and/or in different time slots.

To search programs by Category :

1. Highlight the CATEGORY in the guide menu. You will see currently applicable categories in a two-level structure. The Category Search screen consists of three columns: the first column from the left shows the top-level categories, the middle column shows the second-level categories that belong to the same top-level category, and the right-most column lists programs resulting from a category search.
2. Move the highlight to a top-level category. You will see its second-level categories, if any in the middle column. By moving the highlight around and viewing available categories, you can select any of them, top-level or second-level, and press "↔" for searching.
3. The program resulting from the search will be listed in the right-most column. The highlight goes to the top program on the list and its program information will be displayed at the top region of the guide screen. You can see program information on each program by moving the highlight using "▲▼". If you choose a program and press "↔", you will be asked to select one of the available showings of that program. Once a choice is made, ALL channel listings will replace the Category Search screen and the highlight will go to the specified showing.



7. ADVANCED PROGRAM GUIDE™

7-10. Searching Programs by Keyword

You can also search for programs by keyword that include the keyword in their program titles or credit titles such as actor/actress name, director name, etc.

To search programs by keyword:

1. Move the highlight to the KEYWORD in the guide menu. The Keyword Search screen will appear on the right side of the guide menu.
2. Move the highlight to the right and enter a word using the screen keyboard. Highlight a letter first and press “↵” to type it in.
3. When a word is completed or even when only a partial word is typed in, you may, move the highlight to the Search option located on the bottom of the screen keyboard and press “↵” to execute searching.
4. The receiver first searches for candidate keywords that include the word or the partial word you entered. You can select one of the candidate keywords to search for programs that have or are related to the selected keyword.
5. The programs resulting from the search will be listed in the right-most column. The highlight goes to the top program on the list. Its program information will be displayed at the top region of the guide screen. You can see program information on each program by moving the highlight using “▲▼”. If you choose a program and press “↵”, you will be asked to select one of available showings of that program. Once a choice is made, all channel listings will replace the Keyword Search screen and the highlight will go to the specified showing.

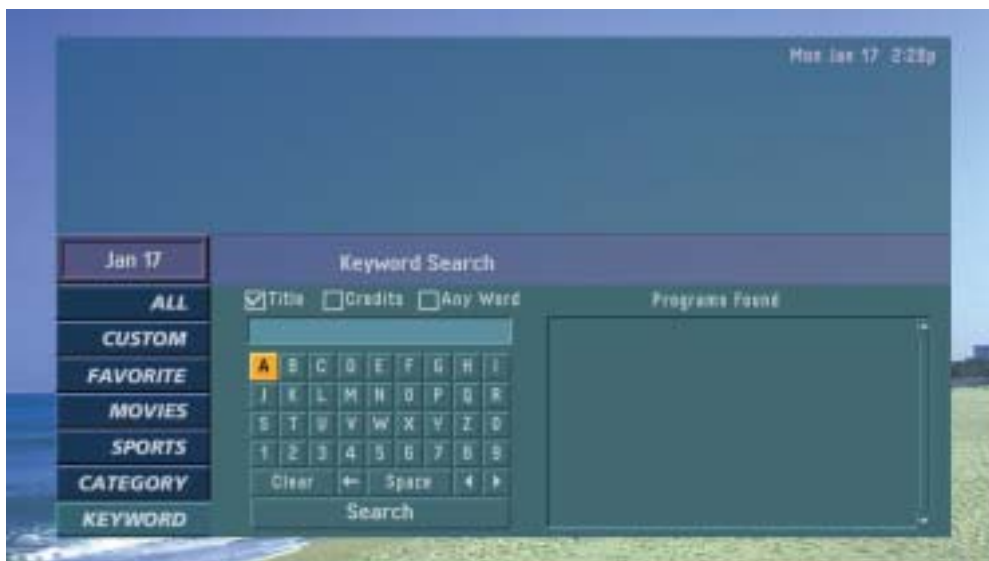

8. CUSTOMIZATION

8-1. The Structure of the On-screen Menu

In this menu system, there are several ways to customize the settings provided. Most menus consist of three levels to set up the options, but some menus go to and require further levels to be set. If you press the **Menu** button, only the first level of the menu system can appear at the left side of the TV screen. The second and third level will be displayed by pressing “↔”. If a menu has more than three levels, the pop-up dialogue box can be displayed as the fourth or fifth level. For navigating the menu levels, you will see “↔” or “▶” on the right side of the menu label to help you go to the next level.

To bring up and exit the Menu:

Press the **Menu** button on the remote control to bring up the menu. A second press of the **Menu** button or a press of the **Exit** button will take you back to TV viewing.

To go to the next level:

Press “↔” or “▶” on the remote control.

To go back to the previous level:

Press “◀” on the remote control.



8. CUSTOMIZATION

8-2. The On-Screen Menu

DIRECTV	Guide Remind List Future Purchase Purchase List Messages Initial Setup
----------------	---

SETUP	Auto Program Manual Ch. Add Favorite/Ch. Edit Hook-up Help Clock Advanced
--------------	--

AUDIO	Digital Output Audio Mode Audio Language
--------------	--

PREFERENCE	Wide Mode Closed Caption Output Channel Out to TV Digital TV Input Auto Demo
-------------------	---

LOCK	Lock System Block Channel Movie Rating TV Rating – Children TV Rating – General Spending Limit
-------------	---

SYSTEM	System Test Replace Card Software Info Feature List
---------------	--

8-3. Previewing the Remind List

The Remind List shows the programs you have reserved in the Guide menu. You may cancel any program in the list by selecting the program. A pop-up screen will ask if you want to cancel it.

To cancel a program in the Remind List:

1. Press the **Menu** button on the Remote Control to display the on-screen menu.
2. Select the DIRECTV® menu by pressing “+” on the remote control.
3. Scroll down to Remind List using “▼”.
4. Move the highlight to the right with “▶” to select a program from the list.
5. Press “+” and the pop-up dialogue box will be displayed.
6. Select “Yes” in the pop-up box if you want to cancel, then the highlight will return to the list.
7. Press “◀” to return to the previous level or press the **Exit** button on the remote control if you want to return to TV viewing.



8-4. Managing Program Purchases

Future Purchase

Allows you to review upcoming DIRECTV® Pay Per View purchases. You may only cancel programs that were ordered through the DIRECTV® High-Definition Receiver and have not been viewed. You may do this by selection the program. A pop-up screen will ask you if you want to cancel the program.

To cancel a newly purchased program :

1. Press the **Menu** button on the Remote Control to display the on-screen menu.
2. Select the DIRECTV® menu by pressing “+” on the remote control.
3. Scroll down to Future Purchase using “▼”.
4. Move the highlight to the right with “▶” to select a program from the list.
5. Press “+” and the pop-up dialogue box will be displayed.
6. Select “Yes” in the pop-up box if you want to cancel, then the highlight will return to the list.
7. Press “◀” to return to the previous level or press the **Exit** button on the remote control if you want to return to TV viewing.



8-4. Managing Program Purchases

Purchase List

Shows you a list of past DIRECTV® Pay Per View purchases. You can see each charge of the PPV programs you purchased and viewed.

To review programs in the Purchase List:

1. Press the **Menu** button on the Remote Control to display the on-screen menu.
2. Select the DIRECTV® menu by pressing “+” on the remote control.
3. Scroll down to the Purchase List using “▼”.
4. Move the highlight to the right with “▶” to scroll the purchase list.
5. Press “◀” to return to the previous level or press the **Exit** button on the remote control to return to TV viewing.



NOTE

CAM: Conditional Access Module, usually referred to as the access card. A removable, electronic subassembly provides conditional access control of the subscriber terminal.

CAM Slot No: The CAM slot number indicates which slot the purchase occupied. A customer service representative may use these slot numbers to help resolve billing issues.

8. CUSTOMIZATION

8-5. Checking the Messages

Allows you to view the messages that are sent from DIRECTV. For example, you may receive a message requesting your attention to a new service or special program offering.

To check the Messages:

1. Press the **Menu** button on the Remote Control to display the on-screen menu.
2. Select the DIRECTV® menu by pressing “**+**” on the remote control.
3. Scroll down to the Messages option using “**▼**”.
4. Move the highlight to the right with “**▶**” to select a mail item from the list.
5. Press “**+**” and the full text of the mail will be displayed in the pop-up dialogue box.
6. Select “Delete” on the pop-up box if you want to delete it.
7. Press “**◀**” to return to the previous level or press the **Exit** button on the remote control if you want to return to TV viewing.



NOTE

The Message icon will be displayed in the Channel Banner only when at least one unread message is in the mail buffer.

8-6. Initializing the System

About Initial Setup

The DIRECTV® High-Definition Receiver is capable of receiving three types of signals; ANT, CABLE and DIRECTV® programming (if you are a DIRECTV® customer). Initial Setup lets you initialize your system to function properly with your dish antenna.

Select Dish

Lets you select the correct dish type among three different types available; Round Dish for Satellite Network A only, Oval Dish for Satellite Networks A and B, or Oval Dish for Satellite Networks A, B, and C. For advice on selecting a dish that will provide the services that you desire, contact DIRECTV (1-800-DIRECTV) or your local DIRECTV retail expert. If you already have a dish, refer to its user's guide to determine its type.

To receive HD programming, you should install and select the Oval dish type (Oval dish (Sat A,B) or Oval dish (Sat A, B, C)) in the Select Dish menu.

Auto Detection is used to enable access to additional DIRECTV® satellites after the dish is pointed. You must select No Dish if you have no dish, and you cannot proceed further in this menu.

To select dish:

1. Press the **Menu** button on the Remote Control to display the on-screen menu.
2. Select the DIRECTV® menu by pressing "↵" on the remote control.
3. Scroll down to Initial Setup using "▼".
4. Move the highlight to the right with "▶" to choose Select Dish.
5. Press "↵" and the pop-up dialog box will be displayed.
6. Select your dish type using "▼" and press "↵".
The highlight will return to the previous screen.
7. Select Your Location using "▼" for the next step of the initial setup.



NOTE

Although the initial setup is a sequential process from Select Dish to Channel Setup, each menu can be accessed independently.

8. CUSTOMIZATION

8-6. Initializing the System

Your Location

Provides the coordinates of elevation, azimuth, and tilt based upon your zip code. Elevation is the up/down angle of the dish. Azimuth is the side-to-side direction, while tilt is the circular rotation of the dish itself around the pointing axis. Full instructions for the installation of your dish are provided with your satellite dish antenna.

To enter your location:

1. Press the **Menu** button on the Remote Control to display the on-screen menu.
2. Select the DIRECTV® menu by pressing “+” on the remote control.
3. Scroll down to Initial Setup using “▼”.
4. Move the highlight to the right with “▶” to select Your Location.
5. Press “+” and the pop-up dialogue box will be displayed.
6. Enter your zip code using the digit buttons on the remote control.
7. Press “+” to show the elevation, azimuth and tilt.
Point your dish properly with the azimuth, elevation and tilt values given.
8. Press “+” to return to the Your Location menu.
9. Select Signal Strength using “▲▼” for the next step of initial setup.



NOTE

Although the initial setup is a sequential process from Select Dish to Channel Setup, each menu can be accessed independently.

8-6. Initializing the System

Signal Strength

Shows you up to three signal strength bars for Satellite Networks A, B, and C, in order to help you adjust the dish to the correct position with the elevation, azimuth, and tilt values obtained from the Your Location menu. While the maximum signal strength is 100, there will be no apparent difference in picture quality between signal strengths of 60 to 85. The higher the signal, the less likely you are to experience degradation when it rains or snows.

A transponder is a receiver/transmitter on the satellite. It receives signals from DIRECTV and retransmits them to your dish. The DIRECTV® High-Definition Receiver is capable of displaying the signal strength of most transponders by using the following method.

To see the signal strength:

1. Press the **Menu** button on the Remote Control to display the on-screen menu.
2. Select the DIRECTV® menu by pressing “+” on the remote control.
3. Scroll down to Initial Setup using “▼”.
4. Move the highlight to the right with “▶” to select Signal Strength.
5. Press “+” and the pop-up dialogue box will be displayed.
6. Move the highlight to select the desired transponder.
7. Press “+” to return to Signal Strength.
8. Select Channel Setup using “▼” for the next step of initial setup.



NOTE

Although the initial setup is a sequential process from Select Dish to Channel Setup, each menu can be accessed independently.

8. CUSTOMIZATION

8-6. Initializing the System

Channel Setup

Searches for all channels available over the air or terrestrial in a selected local area. You can select two distinct areas by Zip code to view the channels being broadcast from both areas. This is useful if you live between two major broadcast centers and are capable of receiving signals from both. After this Channel Setup process, the channel list will be created.

To scan the channels from the satellites:

1. Press the **Menu** button on the Remote Control to display the on-screen menu.
2. Select the DIRECTV® menu by pressing “+” on the remote control.
3. Scroll down to Initial Setup using “▼”.
4. Move the highlight to the right with “▶” to select Channel Setup.
5. Press “+” and the pop-up dialogue box will be displayed to ask if you want to add off-air digital and analog channels to your guide. If you select “NO”, you don’t need to do the following process (6-10).
6. Press “+” if your zip code is correct for the primary local channels. The channel search progress will be shown.
7. If the zip code is missing or incorrect, select the zip code for your city using “▼” and pressing “+”.
8. Select “Yes” in the pop-up box that asks you if you want to add the secondary local channels.
9. Enter the secondary zip code using the digit buttons on the remote control.
10. Repeat from 6 to 7.
11. Press “◀” to return to the previous level or press the **Exit** button on the remote control if you want to return to TV viewing.



NOTE

Although the initial setup is a sequential process from Select Dish to Channel Setup, each menu can be accessed independently.

8-7. Managing Channels

Auto Program (Channel Search)

Automatically finds all channels (both analog and digital) available through the antenna and cable inputs, and stores all the active channels in the channel list. Inactive or weak channels may not appear in the list. In that case, add missing channels manually in the Manual Ch. Add menu. The channel list created here can be shown in the Favorite/Ch. Edit menu.

To scan the channels with the antenna:

1. Press the **Menu** button on the Remote Control to display the on-screen menu.
2. Scroll down using “▼” on the remote control.
3. Select the Setup menu by pressing “↵”.
4. Auto Program will be automatically highlighted.
5. Move the highlight to the right with “▶” to select “Start”.
6. Press “↵” and the moving yellow bar will indicate the progress scanning the channels. When the scanning process begins, “Start” will change to “Next”. If you press “Next”, the scanning of the Antenna signal source will be ignored and the scanning of the next signal source (cable) will proceed. Next the digital signals will be scanned.
7. When the scanning is completed, the scanned result will be displayed.
8. Press the **Exit** button on the remote control if you want to return to TV viewing.



8. CUSTOMIZATION

8-7. Managing Channels

Manual Ch. Add

Manually adds a channel to your channel list without rescanning all the channels again. Auto Program may not pick up every channel that is available on Air and Cable. Therefore, it may be necessary for you to add channels manually using this feature.

To add the channels missed in your channel list:

1. Press the **Menu** button on the remote control to display the on-screen menu.
2. Scroll down using “▼” on the remote control.
3. Select the Setup menu by pressing “↵”.
4. Scroll down to Manual Ch. Add using “▼”.
5. Move the highlight to the right with “▶” to display the channel add box.
6. Enter the channel number desired using the digit buttons on the remote control.
7. Press “↵” and the pop-up box of the result will be displayed.
8. Press the **Exit** button on the remote control to return to TV viewing.



8-7. Managing Channels

Favorite/Ch. Edit

The default channel list is made in the Auto Program menu. Favorite/Ch. Edit allows you to create two other types of channel lists; custom list and favorite list. A custom list can be created by toggling each channel on or off with "⏏". Once a channel is highlighted, you will be able to see whether the channel is currently shown or hidden by referring to the small window at the top-left corner of the screen.

To create your own favorite list, with up to 50 favorite channels, press the **Favorite** button on the remote control when a channel is highlighted.

To edit the channel list:

1. Press the **Menu** button on the remote control to display the on-screen menu.
2. Scroll down using "▼" on the remote control.
3. Select the Setup menu by pressing "⏏".
4. Scroll down to Favorite/Ch. Edit using "▼".
5. Press "▶" to display the channel editing screen.

To create a custom list:

1. Use "▲▼◀▶" to move the highlight on the channel editing menu.
2. Choose "Shown" or "Hidden" by pressing "⏏".
The screen shown at the top left will indicate if the highlighted channel is shown or hidden.

To create a favorite list:

1. Use "▲▼◀▶" to move the highlight on the channel editing menu.
2. Choose "Favorite" or "No Favorite" using the **Favorite** button on the remote control.
6. Press the **Menu** button to return to the previous screen or press the **Exit** button on the remote control to return to TV viewing.

NOTE

Use the "Show All" button to show all the channels.

Use the "Hide All" button to hide all the channels.

These settings may be reset if there is an interruption to the AC power (such as set is unplugged or there is a power failure).

8. CUSTOMIZATION

8-7. Managing Channels



8.8 Hook-up Help

Graphically depicts possible schemes for connecting on the DIRECTV® High-Definition Receiver to your dish antenna and other components. Since the connection that is best for you depends on the components in your system, keep in mind that an alternative connection may also be possible.

To see Hook-up Help:

1. Press the **Menu** button on the remote control to display the on-screen menu.
2. Scroll down using “▼” on the remote control.
3. Select the Setup menu by pressing “-+”.
4. Scroll down to Hook-up Help using “▼”.
5. Press “▶” to display the Hook-up Help diagrams.
Seven possible hook-up connections will be shown.
6. Scroll up and down the hook-up figure options shown to determine the correct connections for your system.
7. Press the **Menu** button to return to the previous screen or press the **Exit** button on the remote control to return to TV viewing.

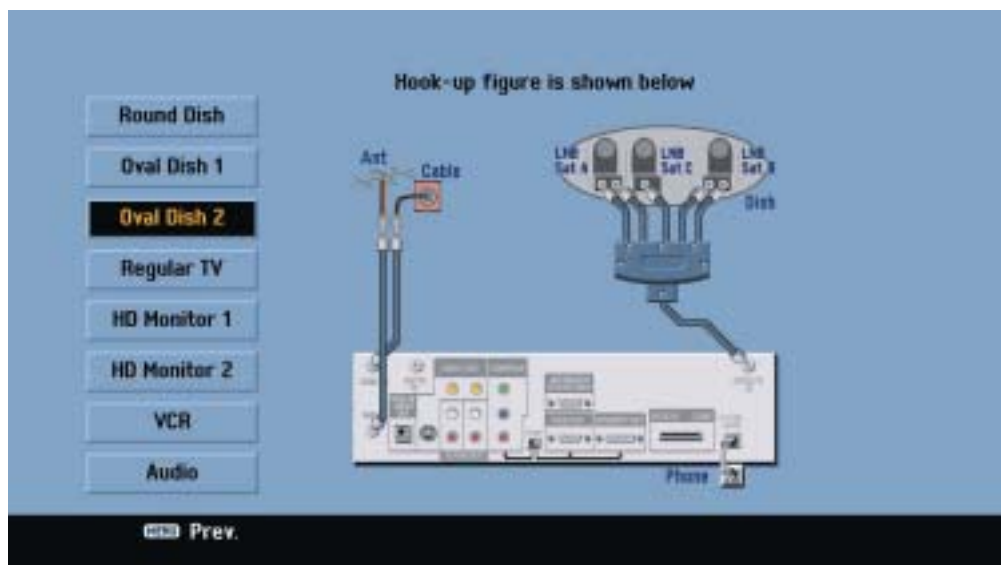

8. CUSTOMIZATION

8-9. Setting the Clock

Clock (Auto)

Enables adjustment of the time zone and activation of daylight savings time. Normally, your clock is set using signals transmitted by DIRECTV.

To set auto clock:

1. Press the **Menu** button on the Remote Control to display the on-screen menu.
2. Scroll down using “▼” on the remote control.
3. Select the Setup menu by pressing “+”.
4. Scroll down to Clock using “▼”.
5. Move the highlight to the right with “▶”.
6. Select your time zone between Eastern and Hawaii by pressing “▶” continuously.
7. Scroll down to Daylight Saving and press “▶” to switch daylight saving on or off.
8. If you want to reset the clock, scroll down again to “Reset” and press “+”.
The highlight will return to the previous level.
9. Press the **Exit** button on the remote control to return to TV viewing.

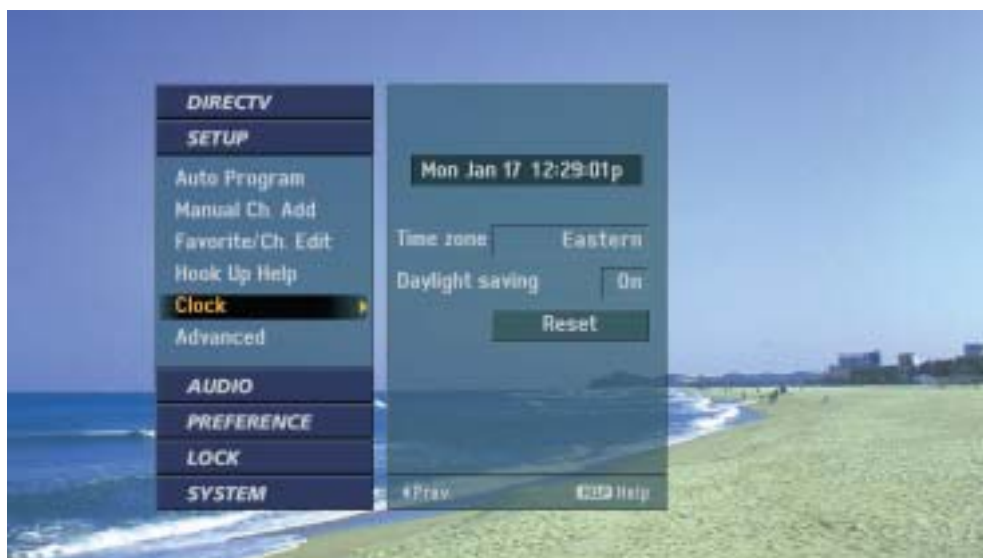

8-9. Setting the Clock

Clock (Manual)

Enables you to set the time manually in the ANT/CABLE Only Operation.

To set manual clock:

1. Press the **Menu** button on the Remote Control to display the on-screen menu.
2. Scroll down using “▼” on the remote control.
3. Select the Setup menu by pressing “+”.
4. Scroll down to Clock using “▼”.
5. Move the highlight to the right with “▶”.
6. Use “▲▼” to move the highlight in the entry boxes.
7. Enter the number by using the digit buttons on the remote control.
8. Press “◀” to return to the previous screen or press the **Exit** button on the remote control to return to TV viewing.



8. CUSTOMIZATION

8-10. Advanced

Advanced Setup

Allows you to configure special settings such as the background matte color for wide aspect ratio programming, the channel banner time-out period, remote control ID selection and advanced digital closed captioning settings.

To set advanced Setup Menu:

1. Press the **Menu** button on the Remote Control to display the on-screen menu.
2. Scroll down using “▼” on the remote control.
3. Select the Setup menu by pressing “+”.
4. Scroll down to Advanced using “▼”.
5. Press “▶” to display the Advanced Setup Menu screen.

Remote ID

Lets you assign one of two remote ID's. This can be useful if you have more than one Sony satellite receiver in one location. While the Remote ID menu is displayed, press the Code Set button, enter either “50” or “51” and press the Enter button. The remote control and DIRECTV® High-Definition Receiver are now set to either remote ID 50 or 51.



8-11. Setting the Audio

Digital Output

If you are using an external audio system that supports Dolby Digital, select Dolby Digital audio mode. If you are using an external audio system that has a PCM only decoder, select PCM (Digital). If you are not using an external audio system, select OFF.



An external Digital Output other than Dolby Digital and PCM may create a high pitched noise and cause damage.

To set the digital audio mode:

1. Press the **Menu** button on the Remote Control to display the on-screen menu.
2. Scroll down using “▼” on the remote control.
3. Select the Audio menu by pressing “↵”.
4. Digital Output will be automatically highlighted.
5. Move the highlight to the right with “▶”.
6. Select one of the three options and press “↵” to return to the previous level.
7. Press the **Exit** button on the remote control to return to TV viewing.



8. CUSTOMIZATION

8-11. Setting the Audio

PCM (Digital)

Pulse Code Modulation (PCM) decoders support L/R stereo only. If selected, audio outputs are decoded and transmitted to the Digital Output (SPDIF) in PCM mode.

Dolby Digital

Dolby Digital, formally known as AC-3 for Audio Coding 3rd Generation or 5.1 channel audio, is a coding technique that provides five independent, full frequency response audio channels and one low frequency bass channel. Dolby Digital signals are available only when provided by the broadcaster.

NOTE

Refer to section 2.5 to see more detailed information.



8-11. Setting the Audio

Audio Mode

Lets you choose the default audio mode when a program is broadcasting in analog format. When you view a program broadcast in mono, you will hear only mono sound, even though Stereo mode is set. When Second Audio Program "SAP" mode is set, the program's second audio program is broadcast in mono, if provided.

To Set the Analog Audio Mode:

1. Press the **Menu** button on the Remote Control to display the on-screen menu.
2. Scroll down using "▼" on the remote control.
3. Select the Audio menu by pressing "↵".
4. Scroll down to Audio Mode using "▼".
5. Move the highlight to the right with "▶".
6. Select one of the three options and press "↵" to return to the previous level.
7. Press the **Exit** button on the remote control to return to TV viewing.



8. CUSTOMIZATION

8-11. Setting the Audio

Audio Language

If available, allows you to hear a program in other languages if the program is broadcast in digital format. You may select a language while you are viewing a program by selecting an option on the audio language box in the channel banner and pressing "▲▼" repeatedly to select the desired language.

To set the digital audio language:

1. Press the **Menu** button on the Remote Control to display the on-screen menu.
2. Scroll down using "▼" on the remote control.
3. Select the Audio menu by pressing "+".
4. Scroll down to Audio Language using "▼".
5. Move the highlight to the right with "►".
6. Select one of the eight language options and press "+." to return to the previous level.
7. Press the **Exit** button on the remote control to return to TV viewing.



8-12. Choosing the Aspect Ratio

Lets you choose the screen format. When you view a high-definition picture using the video 1/2(480i) or 480p output format, you can choose Letterbox, Cropped or Squeezed. When you view a standard-definition picture using the 720p or 1080i output format, you can choose Normal, Wide, Panorama, Zoom1 or Zoom2. (Refer to section 2.4 Normal and Wide Format Signals)

Choosing the screen format of your TV:

1. Press the **Menu** button on the Remote Control to display the on-screen menu.
2. Scroll down using “▼” on the remote control.
3. Select the Preference menu by pressing “+”.
4. Wide Mode will be automatically highlighted.
5. Move the highlight to the right with “▶”.
6. Select one of the options and press “+” to return to the previous level.
7. Press the **Exit** button on the remote control to return to TV viewing.



8. CUSTOMIZATION

8-12. Choosing the Aspect Ratio

Modes for viewing high definition content (16:9) WHEN OUTPUT FORMAT IS 480i OR 480p MODE :

Letter Box

Use for a picture with an original 16:9 aspect ratio (in a wide format). Letterbox mode will shrink the picture to fill the screen, with black/gray (or blank) bars appearing at the top and bottom of the screen.

Cropped

Use for a picture filling the entire screen by cropping (removing) the left and right portions of the picture.

Squeezed

Use for a full picture filling the entire screen with no black/gray bars. The picture in a 16:9 format will be horizontally adjusted or squeezed to fit the 4:3 ratio monitor. This setting can also be useful when used with 16:9 aspect ratio monitors or with 4:3 aspect ratio monitors that have a "16:9 enhancement" feature.

Modes for viewing standard definition content (4:3) WHEN OUTPUT FORMAT IS 720p OR 1080i MODE :

Normal

Use for a picture with an original 4:3 aspect ratio on your 16:9 monitor, with black/gray bars appearing at the left and right sides.

Wide

Use for a picture adjusted horizontally (in a linear proportion) to fill the entire screen.

Panorama

Use to adjust a picture in a non-linear proportion (more at both sides) to create a spectacular view.

Zoom1

Use when you want to fill the entire screen with no black/gray bars appearing. The image will be altered both horizontally (stretched) and vertically (cropped). The top and bottom portions of the picture will be cut.

Zoom2

Use to view the picture without distortion. Note that the top and bottom portions of the picture will be cropped (removed).

8-13. Setting Closed Caption

Lets you select a mode for displaying Closed Caption Data. You can choose the Analog Caption Service or the Digital Caption Service. In the Analog Caption Service, Caption 1-4 display program's dialog, and Text 1-4 display information for a data service. In the Digital Caption Service, Service 1-6 represent each Language Service.

(Note : Closed Caption will appear only when it is provided by the broadcaster)

To set Closed Caption:

1. Press the **Menu** button on the Remote Control to display the on-screen menu.
2. Scroll down using "▼" on the remote control.
3. Select the Preference menu by pressing "⏏".
4. Scroll down to Closed Caption using "▼".
5. Move the highlight to the right with "▶".
6. Select one between Analog Caption Service and Digital Caption Service.
7. Move the highlight to the right with "▶".
8. Select one of the options and press "⏏" to return to the previous level.
9. Press the Exit button on the remote control to return to TV viewing.



8. CUSTOMIZATION

8-13. Setting Closed Caption

Analog Caption Service

Caption1 (CC1)

CC1 is the primary caption service that synchronizes the captioning language with the sound, used by most broadcasters. The captioning is displayed in the same language as the program's dialog.

Caption2 (CC2)

CC2 is the special non-synchronous caption service that does not need to be in sync with the sound and may provide simplified captioning, which is usually delayed.

Caption3 (CC3)

CC3 serves as an alternate captioning service channel. The captioning is often a secondary language translation such as French, Spanish, simplified English or displayed at a slower rate.

Caption4 (CC4)

CC4 is another special non-synchronous caption service that does not need to be in sync with the sound and may provide simplified captioning, usually delayed.

Text1-4

Text1-4 usually display information at the bottom position and is used for a data service, generally not program related.

Digital Caption Service

Service 1 is designated as the Primary Caption Service. This service contains the verbatim, or near-verbatim captions for the primary language being spoken in the accompanying program audio.

Service 2

Service 2 is designated as the Secondary Language Service. This service contains captions in a secondary language which are translations of the captions in the Primary Caption Service.

Service 3-6

The other services are not pre-assigned. It is up to the discretion of the individual caption provider to utilize the remaining service channels.

8-14. Setting Default Signal Out

Output Channel

Lets you choose the channel used to view the DIRECTV® High-Definition Receiver when connected to the TV from the "OUT TO TV" jack, either channel 3 or 4. Make sure your TV is set to the selected channel and that the DIRECTV HD Receiver's Format is set at "Video 1/2".

To set the channel number of the DIRECTV HD Receiver:

1. Press the **Menu** button on the Remote Control to display the on-screen menu.
2. Scroll down using "▼" on the remote control.
3. Select the Preference menu by pressing "↵".
4. Scroll down to Output Channel using "▼".
5. Move the highlight to the right with "▶".
6. Select Channel 3 or 4 and press "↵" to return to the previous level.
7. Press the **Exit** button on the remote control to return to TV viewing.



8. CUSTOMIZATION

8-14. Setting Default Signal Out

Out to TV -- Default Connection

Lets you choose whether the OUT TO TV jack is connected to either the CABLE IN or ANT IN jack in standby mode.

To set the standby mode default signal source:

1. Press the **Menu** button on the Remote Control to display the on-screen menu.
2. Scroll down using "▼" on the remote control.
3. Select the Preference menu by pressing "↵".
4. Scroll down to Out to TV using "▼".
5. Move the highlight to the right with "▶".
6. Select Antenna or Cable and press "↵" to return to the previous level.
7. Press the **Exit** button on the remote control to return to TV viewing.



8-15. Setting the Digital TV Input

Digital TV Input

The DIRECTV® High-Definition Receiver is also capable of receiving an 8-VSB signal, if any, via cable service. Before you move the highlight in the sub menu, the dialogue box will pop up to make sure if you want to change the mode. After changing it, you should run "Auto Program" to view a program sent via the designated input.

To set the Digital TV signal source:

1. Press the **Menu** button on the Remote Control to display the screen menu.
2. Scroll down using "▼" on the remote control.
3. Select the Preference menu by pressing "↔".
4. Scroll down to Digital TV Input using "▼".
5. Move the highlight to the right with "▶".
6. The pop-up dialogue box will appear when you move the highlight to change the mode.
7. Choose "OK " if you want to change the mode, Otherwise, choose "Cancel".
8. Press the **Exit** button on the remote control to return to TV viewing.



8. CUSTOMIZATION

8-16. Running Auto Demo

Shows you how to navigate through the on-screen menus of the DIRECTV® High-Definition Receiver.

To run Auto Demo:

1. Press the **Menu** button on the Remote Control to display the on-screen menu.
2. Scroll down using “▼” on the remote control.
3. Select the Preference menu by pressing “+”.
4. Scroll down to Auto Demo using “▼”.
5. Press “▶” to display the Auto Demo screen.
The screen will run automatically.
6. Press “◀” anytime to return to the previous screen or press the **Exit** button on the remote control to return to TV viewing.



8-17. Setting Locks

Lock System

Lets you set up specific channels, ratings and spending limits through blocking schemes. Activates or disables all of the lock schemes previously set up. A password is required to gain access to this menu if the lock system is activated. You can change the password by inputting a new password twice. When the system is unlocked, the Block Channel, Program Rating and Spending Limits are not effective.

To activate or deactivate the Lock System:

1. Press the **Menu** button on the Remote Control to display the on-screen menu.
2. Scroll down using “▼” on the remote control.
3. Select the Lock menu by pressing “+”.
4. If unlocked, Lock System will be automatically highlighted, otherwise requires a password.

To lock the system:

1. Move the highlight to the right with “▶” in Lock On/Off box.
2. Switch On or Off by using “▶” Whenever you switch the lock system on, you need to enter the password as a reminder.

To set the password:

1. Move the highlight to the Set Password with “▼”.
 2. Enter the password by using the digit buttons on the remote control.
 3. Enter the password again to verify the number.
5. Press “◀” to return to the previous screen or press the **Exit** button on the remote control to return to TV viewing.



NOTE

Once you enter the password when unlocking the blocked channel, it will remain unlocked until the DIRECTV® High-Definition Receiver is off.

8. CUSTOMIZATION

8-17. Setting Locks

Block Channel

Blocks any channels that you do not want to view or that you do not want your kids to watch. If you tune in a blocked channel, a black screen with a pop-up screen will appear. You will have to enter the correct password to view the channel. Once you turn off the DIRECTV® High-Definition Receiver, Block Channel will automatically be reactivated.

To block channels:

1. Press the **Menu** button on the Remote Control to display the on-screen menu.
2. Scroll down using “▼” on the remote control.
3. Select the Lock menu by pressing “↵”.
4. Scroll down to Block Channel using “▼”.
5. Press “▶” to display the Block Channel screen.
6. Use “▲▼◀▶” to move the highlight in the channel editing screen.
7. Toggle Blocked or Unblocked by pressing “↵”.
The screen shown at the top left will indicate if the highlighted channel is blocked or unblocked.
8. Press “◀” to return to the previous screen or press the **Exit** button on the remote control to return to TV viewing.



NOTE

When you tune to the blocked channel, the password is required for access.

The Channel Block feature should not be used as the only parental control. Since station assignments may change from time to time, controls such as rating and spending limits should always be used as the primary parental control. Additionally, the Channel Block settings may be reset if there is an interruption to the AC power (such as set is unplugged or there is a power failure).

8-17. Setting Locks

Movie Rating

Blocks movies according to the movie ratings limit, as defined by the Motion Picture Association of America, so children cannot view certain movies. You can set the ratings limit by blocking out all the movies with the ratings above a specified level. Keep in mind that the movie ratings limit applies only to movies shown on TV, not TV programs such as soap operas.

To block movie programs:

1. Press the **Menu** button on the Remote Control to display the on-screen menu.
2. Scroll down using “▼” on the remote control.
3. Select the Lock menu by pressing “+”.
4. Scroll down to Movie Rating using “▼”.
5. Select the level you want using “▲▼” and press “+” to return to the previous level.
6. Press the **Exit** button on the remote control to return to TV viewing.



NOTE

MOVIE/MPAA rating

G: General Audiences

All ages admitted.

PG: Parental Guidance Suggested.

Some material may not be suitable for children.

PG-13: Parents Strongly Cautioned

Some material may not be appropriate for children under 13.

R: Restricted Under 17 requires accompanying parent or adult guardian.

NC-17: No one 17 and under admitted.

X: No one 17 and under admitted.

8. CUSTOMIZATION

8-17. Setting Locks

TV Rating for Children's Programs

Keeps children from watching certain children's TV programs according to the ratings limit as defined by the TV Parental Guidelines Monitoring Board. This rating applies only to TV programs for children. Unless you block TV programs intended for mature audiences in the TV Rating – General menu, your children may view those programs.

To block TV programs:

1. Press the **Menu** button on the Remote Control to display the on-screen menu.
2. Scroll down using "▼" on the remote control.
3. Select the Lock menu by pressing "↵".
4. Scroll down to TV Rating-Children using "▼".
5. Select Age or Content, if you want to lock a TV program based on age or content.
6. Select the level you want using "▲▼" and press "↵" to return to the previous level.
7. Press the **Exit** button on the remote control to return to TV viewing.



NOTE

TV Rating Children Programs

TV-Y: All Children.

This program is designed to be appropriate for all children.

TV-Y7: Directed to Older Children.

This program is designed for children age 7 and above.

8-17. Setting Locks

TV Rating for General Programs

Blocks TV programs that you and your family do not wish to watch, based on the rating scheme defined by the TV Parental Guidelines Monitoring Board.

To block TV programs:

1. Press the **Menu** button on the Remote Control to display the on-screen menu.
2. Scroll down using “▼” on the remote control.
3. Select the Lock menu by pressing “-⊕-”.
4. Scroll down to TV Rating-General using “▼”.
5. Select Age or Content, if you want to lock a TV program based on age or content.
6. Select the level you want using “▲▼” and press “-⊕-” to return to the previous level.
7. Press the **Exit** button on the remote control to return to TV viewing.



NOTE

TV Rating for General Programs

TV-G: General Audience.

Most parents would find this program suitable for all ages.

TV-PG: Parental Guidance Suggested.

This program contains material that parents may find unsuitable for younger children.

TV-14: Parents Strongly Cautioned.

This program contains some material that many parents would find unsuitable for children under 14 years of age.

TV-MA: Mature Audience Only.

This program is specifically designed to be viewed by adults and therefore may be unsuitable for children under 17.

8. CUSTOMIZATION

8-17. Setting Locks

Spending Limit

Sets the spending limit of each PPV program. After a spending limit is set and the system is locked, you must enter the password to purchase a PPV program that costs more than your spending limit allows. The system will temporarily unlock the limit you previously set. Once the receiver is turned off and then turned back on, the lock will be reactivated.

To set the spending limit of each PPV program:

1. Press the **Menu** button on the Remote Control to display the on-screen menu.
2. Scroll down using “▼” on the remote control.
3. Select the Lock menu by pressing “↵”.
4. Scroll down to Spending Limit using “▼”.
5. Move the highlight to the right with “▶”.
6. Enter the maximum amount of money to be spent on each PPV program.
7. Press “↵” to return to the previous level.
8. Press the **Exit** button on the remote control to return to TV viewing.



8-18. Testing the System

Checks the integrity of the DIRECTV® High-Definition Receiver. If any problems are detected, a short message will be displayed.

To test DIRECTV HD Receiver :

1. Press the **Menu** button on the Remote Control to display the on-screen menu.
2. Scroll down using “▼” on the remote control.
3. Select the System menu by pressing “+”.
4. System Test will be automatically highlighted.
5. Move the highlight to the right with “▶”.
6. Press “+” to activate the system test.
It will run automatically from Signal Strength to Phone Connection and if there is any problem in your system, the pop-up box will be displayed.
The highlight will return to the previous level after the process is finished.
7. Press the **Exit** button on the remote control to return to TV viewing.



8. CUSTOMIZATION

8-19. Replace Card

DIRECTV may issue you a replacement access card periodically, if you are a DIRECTV customer. This menu enables you to transfer information, such as the record of your purchases, from the old card onto a new one. The access card fits into the slot on the back panel of the DIRECTV® High-Definition Receiver.

 Once you proceed past “Read the old card”, replace card cannot be cancelled.

To replace the card :

1. Press the **Menu** button on the Remote Control to display the on-screen menu.
2. Scroll down using “▼” on the remote control.
3. Select the System menu by pressing “↵”.
4. Scroll down to Replace Card using “▼”.
5. Move the highlight to the right with “▶”.
6. Press “↵” to activate the Replace Card.

The pop-up box will be displayed. If you want the process to proceed, follow the instructions in the pop-up box. The highlight will return to the previous level after the process is finished.

7. Press the **Exit** button on the remote control to return to TV viewing.



8-20. Upgrading Software

Shows you the current software version. If there is a software upgrade planned, you will be notified by a pop-up box on your TV screen and the pop-up box will ask you if you want to upgrade your system.

To upgrade the software in the DIRECTV® High-Definition Receiver:

1. Press the **Menu** button on the Remote Control to display the on-screen menu.
2. Scroll down using “▼” on the remote control.
3. Select the System menu by pressing “↵”.
4. Scroll down to S/W Upgrade using “▼”.
5. You can see the current software version on the right side of the menu.
The next version will be seen if DIRECTV plans to upgrade the software.
6. Press the **Exit** button on the remote control to return to TV viewing.

The DIRECTV HD Receiver is able to receive upgrades or modifications to some of its features and functions. These modifications will automatically be made, usually at times when the receiver would likely be turned off. If your receiver is on when an upgrade or modification is sent, you may experience a disruption in reception for a minute or two. Your reception should return to normal after the modification is complete. Your receiver must be plugged in to receive any upgrades. Please consult the Upgrade Menu to find a schedule of upgrades or modifications planned by DIRECTV.

(Note: Do not unplug your receiver while an upgrade is in progress.)



9. Help

9-1. Help

The Help feature is designed to let you understand each function of the Menu and Advanced Program Guide™ in an easy and convenient way. When you navigate through the Menu and the Advanced Program Guide™, press and hold the **“Help”** button on your remote control if you want information about the highlighted item. The information will be displayed on the right side of the TV screen.

Simply press and hold to see the helpful information.

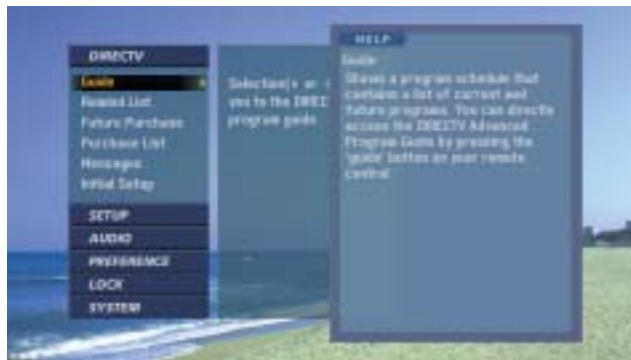

NOTE

Pressing the **“Help”** button on your remote control independently will activate the overall Help feature. However, when the MENU or the Advanced Program Guide™ is already displayed, pressing the **“Help”** button will activate the specific Help feature.

9-1. Help

The Help is an on-line version of this Operating Guide. You can review many features of the DIRECTV® High-Definition Receiver by navigating through a simple structure. It contains a brief overview of the DIRECTV HD Receiver, the use and programming of the remote control, a functional explanation of the front and back panel, and an instructive note about the Menu and the Advanced Program Guide™.

The see the Help feature:

1. Press the “**Help**” button on the remote control to display the Help screen.
2. Scroll up and down to select Help menu items using “**▼**” on the remote control.
3. Move the highlight using “**▲▼◀▶**”.
The explanations of the highlighted item will be displayed on the right side or at the bottom of the screen.
4. Press the **Exit** button on the remote control if you want to return to TV viewing.



Remote Control/Programming Remote



Front & Back panel



Menu and Advanced Program Guide™

PRODUCT SPECIFICATIONS

Television System	NTSC, Analog American Standard (480i) ATSC, Digital TV standard (1080i, 720p, 480p, 480i) DIRECTV
--------------------------	---

Channel Coverage	
Digital TV	1-69
VHF	2-13
UHF	14-69
CATV	1-125
DIRECTV	variable

Inputs/Output	
ATSC/NTSC RF Inputs	Antenna (1), Cable TV (1) (ATSC 8-VSB over CATV or Terrestrial)
RF Output	Out To TV (1) (selectable Channel 3 or 4)
DIRECTV RF Input	Satellite In (1)
DVI-HDTV Output	DVI-HDTV Out (1), DVI-D Single Link connector 1080i, 720p, 480p digital RGB EIA-861 Compliant, HDCP Compliant
RGB Output	15-pin Connector (1) 1080i, 720p, 480p RGB
Component Video Output	Component Out (1), Phono Jack connector 1080i, 720p, 480p YPbPr
S-Video Output	S-Video Out (1), 4-pin Mini-DIN 480i Y/C
Video Output	Video Out (2), Phono Jack connector 480i Composite NTSC
Digital Audio	Optical (selectable Dolby Digital or PCM output)
Analog Audio	Audio Out (2) (Fixed Output Level)
Access Card	Smart Card (Slot on the back)
Authorized Service Port	9-pin Serial Port (1)

Supplied Accessories	
Remote Control	RM-Y815
Batteries	AA type Batteries (2)
Cables	DVI-D Single Link Cable (1) Component Cable (1) S-Video Cable (1) Audio/Video Cable (1) RF Cable (2) Telephone Cable (1)

Dimension	430mm (W) x 69mm (H) x 329mm (D) (Excluding Foot)
Mass	3.84kg

Power Requirements	AC 120V, 60Hz
Power Consumption	100W (Maximum) 35W (Standby)

Design and specifications are subject to change without notice.

TROUBLESHOOTING

Sony and DIRECTV are dedicated to providing you with quality support and customer service. If you have questions or difficulties that you cannot resolve using the tips in this troubleshooting section, consult your dealer or call DIRECTV at 1-800-DIRECTV (1-800-347-3288) regarding DIRECTV® Service problems and contact the Sony Satellite System Information Center at 1-800-838-7669 regarding problems with DIRECTV® High-Definition Receiver.

SYMPTOMS	SOLUTIONS
No power.	<ul style="list-style-type: none"> - Is the AC power cord plugged in?
Snowy picture and unclear sound.	<ul style="list-style-type: none"> - Check your antenna input or location. - Check your cable input. - Check your satellite input.
No picture.	<ul style="list-style-type: none"> - Make sure that the correct format is selected. If the DIRECTV HD Receiver is connected to your monitor or TV via video 1 or 2 jacks on the back panel, the format must be video 1/2. Otherwise, you may not be able to see a picture. Press the Format button on the front panel to change format (see section 3-5) - If the DIRECTV HD Receiver is connected to your monitor or TV via the Y/PB/PR port or RGB/DVI-HDTV port on the back panel, the format must not be video 1/2. Otherwise, you may not be able to see a picture. (see section 3-5) - Make sure that the right component type is selected. If the DIRECTV HD Receiver is connected to your monitor or TV via Y/PB/PR port on the back panel, the "TYPE" switch must be flipped to the left. Otherwise, you may not be able to see a picture. (see section 3-5) - If the DIRECTV HD Receiver is connected to your monitor or TV via RGB/DVI-HDTV port on the back panel, the "TYPE" switch must be flipped to the right. Otherwise, you may not be able to see a picture. (see section 3-5) - Select the Auto Program or Manual Channel Add functions if you have not already done so. (see section 8-7) - If you are only receiving a few satellite channels, you may need to call your service provider to have your programming activated. - Check to make sure all the cables are installed correctly and that the proper source is selected on your TV. For example, channel 3 or 4, Video 1 or 2. - The satellite signal strength may be low. Check the signal strength and adjust the satellite dish as recommended by the satellite antenna installation instructions. (see section 8-6) - You may be trying to access a pay per view program. Follow the on-screen instructions to order the program. - Due to copyright restrictions, you may not be able to view some high definition programs in the high definition format. - Make sure the Access Card is inserted correctly. - For more information about connections, please refer to Section 3 of this manual.

TROUBLESHOOTING

SYMPTOMS	SOLUTIONS
Normal picture but no sound.	<ul style="list-style-type: none"> - Check volume levels. - Make sure the TV is not muted. - Check that the DIRECTV® High-Definition Receiver is connected properly.
Picture is distorted.	<ul style="list-style-type: none"> - Make sure the proper format is selected. (see section 2-3) - Make sure the proper aspect ratio is selected. (see section 2-4) - Make sure the video output is connected to the TV. (see section 3-5)
Available channels are missing.	<ul style="list-style-type: none"> - If you are a DIRECTV customer, you can add a channel by running the "Manual Ch. Add" from the SETUP menu or find all available channels by running the "Auto Program" in the SETUP menu. (see section 8-7) - Otherwise, if the DIRECTV Receiver is in the ANT/CABLE mode, the only way that you can find all the available channels is by running the "Auto Program" in the SETUP menu. (see section 8-7)
4:3 Aspect ratio cannot be selected.	<ul style="list-style-type: none"> - Aspect ratio depends on both the incoming program format and the Format button on the front panel. Once the button for the format is set to a standard definition (480i/480p) and the incoming program is standard definition, the aspect ratio can not be adjusted and a warning message will appear on the screen. (see section 8-12)
16:9 Aspect ratio cannot be selected.	<ul style="list-style-type: none"> - Similar to the above case, once the button for a format is set to high definition (720p/1080i) and an incoming program is high definition, the aspect ratio can not be adjusted and a warning message will appear on the screen. (see section 8-12)
The remote control is not responding.	<ul style="list-style-type: none"> - Make sure the batteries are fresh and installed properly. - Point the remote control unit at the remote control sensor. - Check if the correct operating mode on the remote control is selected.
The timer does not work.	<ul style="list-style-type: none"> - Make sure the clock is set properly. (see section 8-9)
You forget your password.	<ul style="list-style-type: none"> - If you subscribe to satellite service, contact your service provider to arrange for the password to be re-set - If you do not subscribe to satellite service and the DIRECTV HD Receiver is in the ANT/CABLE mode, enter the master password "7777".

Limited Warranty

Digital Satellite Receivers

SONY ELECTRONICS INC. ("SONY") warrants this Product against defects in material or workmanship as follows:

1. Labor: For a period of 90 days from the original date of purchase, if the Product is determined to be defective, SONY will repair or replace the Product at no charge. After this 90 day period, you must pay for all labor charges.
2. Parts: For a period of one year from the original date of purchase, SONY will supply, at no charge, new or rebuilt replacements in exchange for defective parts. Any replacements will be warranted for the longer of the remainder of the original warranty period or 90 days from the installation of the parts by a Sony authorized DIRECTV® System installer or facility.

To obtain warranty service:

- If the Product was installed by a SONY authorized DIRECTV System installer, contact that installer for instructions.
- If the Product was not installed by a SONY authorized DIRECTV System installer, you must take the Product or deliver the Product in either its original packaging or packaging affording an equal degree of protection (with freight prepaid), to a SONY authorized DIRECTV System service facility. To locate the closest such facility, please call the telephone number listed below.

This warranty does not cover customer instruction, installation, set up adjustments or signal reception problems. This warranty does not cover cosmetic damage or damage due to acts of God, accident, misuse, abuse, negligence, commercial use, or modification of, or to any part of the Product. This warranty does not cover improper installation (if not installed by a SONY authorized DIRECTV System installer), loss of use of the Product malfunction. This warranty does not cover damage due to improper operation or maintenance, connection to improper voltage supply, or attempted repair by anyone other than a facility authorized by SONY to service the Product. This warranty does not cover Products sold AS IS or WITH ALL FAULTS. This warranty is valid only in the United States. Proof of purchase in the form of a bill of sale or receipted invoice which is evidence that the Product is within the Warranty period must be presented to obtain warranty service.

REPAIR OR REPLACEMENT AS PROVIDED UNDER THIS WARRANTY IS THE EXCLUSIVE REMEDY OF THE CONSUMER. SONY SHALL NOT BE LIABLE FOR ANY INCIDENTAL OR CONSEQUENTIAL DAMAGES FOR BREACH OF ANY EXPRESS OR IMPLIED WARRANTY ON THIS PRODUCT. IN NO EVENT SHALL SONY BE LIABLE FOR ANY INCIDENTAL OR CONSEQUENTIAL DAMAGES WHATSOEVER ARISING OUT OF THE USE OR INABILITY TO USE THE PRODUCT. UNDER NO CIRCUMSTANCES SHALL SONY'S LIABILITY, IF ANY, EXCEED THE PURCHASE PRICE PAID FOR THE PRODUCT. EXCEPT TO THE EXTENT PROHIBITED BY APPLICABLE LAW, ANY IMPLIED WARRANTY OF MERCHANTABILITY OR FITNESS FOR A PARTICULAR PURPOSE ON THIS PRODUCT IS LIMITED IN DURATION TO THE DURATION OF THIS WARRANTY.

This warranty is invalid if the factory applied serial number has been altered or removed from the Product. Some states do not allow the exclusion or limitation of incidental or consequential damages, or allow limitations on how long an implied warranty lasts, so the above limitations or exclusions may not apply to you. In addition, if you enter into a service contract with the SONY Partnership within 90 days of the date of sale, the limitation on how long an implied warranty lasts does not apply to you. This warranty gives you specific legal rights, and you may have other right which vary from state to state.

For your convenience, SONY ELECTRONICS INC. has established telephone numbers for frequently asked questions:

For assistance with installation, contact the dealer from whom you purchased your Digital Satellite Receiver.

For product information or operation, for service assistance or for resolution of a service problem, call:

SONY SATELLITE SYSTEM INFORMATION CENTER 1-800-838-SONY (7669)

For an accessory or part not available from your authorized dealer, call:

1-800-488-SONY (7669)

About Sony Customer Support

Every DIRECTV System manufactured by Sony comes with Sony's Express Support at no charge to you. In the event of a system failure, our Express Support Program can have a replacement receiver on its way to you via overnight Federal Express (for calls Monday-Friday until 7:30 pm Eastern Time; Saturday delivery depends upon zip code). All it takes is a valid credit card to cover a security deposit, and Sony will pay freight in both directions. Our Express Support continues with our 800 number, staffed by dedicated technical representatives who can answer questions on dealer locations, system operation, installation, hookup, accessories, and how to get the most out of your home entertainment system. Sony's Express Support program: another expression of our commitment to excellence in customer service.

Software License Agreement

License and Restrictions

Sony Electronics Inc. ("Sony") grants User a license to Use one copy of the software which is provided to you as part of this Sony product ("software"). "Use" means storing, loading, installing, executing or displaying the Software. Use may not copy, modify the Software or disable any licensing or control features of the Software. No portion of the Software may be reproduced in any form, or by any means, without prior written permission from Sony. User is not permitted to modify, distribute, publish, transmit or create derivative works of any Software included for any public or commercial purposes. In consideration of this authorization, User agrees that any copy of this Software which User makes shall retain all copyright and other proprietary notices in the same form and manner as on the original. Except as specified above, nothing contained herein shall be construed as conferring by implication, estoppel or otherwise any license or right under any patent, trademark or copyright of Sony, its affiliates or any third party licensor. User may not in any way sell, lease, rent, license, sublicense or otherwise distribute the Software. The software may only be accessed by the functionality of the Sony product in which the Software is incorporated by Sony (the "Product(s)"), and a User shall not intentionally make the Software directly accessible to others or to hardware other than the Products, or otherwise expose an API. Nothing in this Agreement grants User any rights, license or interest with respect to source code of the Software. User shall not modify, translate, reverse engineer, decompile or disassemble the Software or any part thereof or otherwise attempt to derive source code or create derivative works therefrom, and shall not authorize any third party to do any of the foregoing provide to User updates and other support services for the licensed Software. All updates provided to User shall constitute licensed Software under this License, and such updates shall be governed by the terms hereof.

Intellectual Property

The Software is owned and copyrighted by Sony, its affiliates or its third party licensors. User's license confers no title or ownership in the Software and is not a sale of any rights in the Software. Sony's affiliates and/or third party suppliers may protect their rights directly in the event of any User's violation of this Agreement. The trademarks, tradenames, Product designation, logos and service marks ("Marks") displayed with this Software are the property of Sony, its affiliates or third party licensors, and User shall acquire no rights of any kind in or to any Mark under which the Software and/or Products are marketed. User is not permitted to use these Marks without the prior written consent of Sony, its affiliates or the applicable third party licensor which may own the Mark.

"Sony" is a registered trademark of Sony Corporation. User agrees not to remove, alter or destroy any patent, trademark or copyright markings or notices placed upon or contained within the Software, User Manuals or documentation. User further agrees to insert and maintain with the Software and any documentation a copyright notice in User's name.

Termination

User's license will automatically terminate upon any transfer of the Product. Upon transfer, User must deliver the software, including any copies and related documentation, to the transferee. The transferee must accept these License Terms as a condition to the transfer. Otherwise, Sony does not authorize the transfer and the User and transferee will be in violation of this Agreement should the transferee use the Product. This license will automatically terminate upon User's failure to comply with any of these License Terms. Upon termination, User must stop using the Product and immediately destroy the Software, together with all copies, adaptations and merged portions in any form and/or return it to Sony.

Export Requirements and U.S. Government Restricted Rights

User may not export or re-export the Software or any copy or adaptation in violation of any applicable laws or regulations. The Software and documentation have been developed entirely at private expense and are provided as "Commercial Computer software - Restricted Rights" in accordance with FAR 52.227-19 (1987) or limited rights provided for such Software and documentation by the applicable FAR or DFARS clause or this Sony Software License Agreement.

Limited Warranty

Sony warrants to User that the Software will not fail to execute its programming instructions due to defects in material and workmanship for a period equal to the warranty period provided for the Product when properly installed and used. Warranty does not apply to defects resulting from (a) improper or inadequate maintenance, (b) software, interfacing, parts or supplies not supplied by Sony, (c) unauthorized modification of the Software or the Product, or (d) improper site preparation or maintenance. If Sony receives notice of a covered defect(s) during the warranty period, Sony will replace Software that does not execute its programming instructions due to such defect(s). Sony does not warrant that the operation of the Software and / or Product will be uninterrupted or error free. If Sony is unable, within a reasonable time, to repair or replace any Software to a condition as warranted, User shall be entitled to a refund of the purchase price upon prompt return of the Product. **EXCEPT AS SPECIFICALLY STATED ABOVE, THE SOFTWARE IS PROVIDED "AS IS" WITHOUT WARRANTY AND SONY, ITS AFFILIATES AND ITS THIRD PARTY LICENSORS DISCLAIM ANY IMPLIED WARRANTY OF NON INFRINGEMENT, MERCHANTABILITY OR FITNESS FOR A PARTICULAR PURPOSE. THE REMEDIES IN THIS WARRANTY STATEMENT ARE USER'S SOLE AND EXCLUSIVE REMEDIES. EXCEPT AS INDICATED ABOVE, IN NO EVENT WILL SONY, ITS AFFILIATES OR ANY OF ITS THIRD PARTY LICENSORS BE LIABLE FOR LOSS OF DATA OR FOR DIRECT, INDIRECT, SPECIAL, INCIDENTAL, CONSEQUENTIAL (INCLUDING LOST PROFIT), EXEMPLARY, OR OTHER DAMAGE, WHETHER BASED IN CONTRACT, TORT, OR OTHERWISE, EVENT IF SUCH PARTY HAS BEEN ADVISED OF THE POSSIBILITY OF SUCH DAMAGES. IN NO EVENT WILL SONY OR ANY OF ITS AFFILIATES OR THIRD PARTY LICENSOR'S LIABILITY UNDER AGREEMENT, WHETHER IN CONTRACT, TORT OR OTHERWISE, EXCEED THE COST OF THE PRODUCT.**

General

This Agreement shall be deemed to have been made and executed in the State of California and both parties agree that any dispute arising hereunder related to this Agreement or the Product will be governed by laws of the State of California, exclusive of its conflicts of law principles and that the courts in the County of San Diego, California will have exclusive jurisdiction over all such disputes. **FURTHER THE PARTIES HEREBY WAIVE TRIAL BY JURY IN CONNECTION WITH ANY ACTION OR SUIT ARISING UNDER THIS AGREEMENT OR OTHERWISE ARISING FROM THE RELATIONSHIP BETWEEN THE PARTIES HERETO.** This Agreement shall be binding upon the parties' authorized successor and assignees. Neither party's waiver of any breach or failure to enforce any of the provisions of this Agreement at any time shall in any way affect, limit or waive such party's right thereafter to enforce and compel strict compliance with every other provision. No modification of this Agreement shall be effective unless in Writing signed by both parties.

Index

A

AC-3 14, 75
Access Card 21, 93
Advanced Program Guide (APG) 16, 46-55
Advanced Setup 73
Analog Audio Signals 15
Analog TV Connection 27
ANT IN Jack 23, 23-31
Antennas Connection 23-26
Arrow Keys, on front panel 34
Aspect Ratio Setting 78, 79
ATSC 10
Audio Connection 32, 33
Audio Language 77
Audio Mode 76
Audio Out Jacks 21
Audio Setting 74-77
Authorized Service Only 21
Auto DVI 11
Auto Program 66
Azimuth 63

B

Back Panel 20, 21
Batteries 18, 19
Block Channel 87

C

Cable In Jack 21, 23-31
Cables 18, 19
CC button 36
Channel Banner 42, 43
Channel Setup 65
Clock Setting 71, 72
Closed Caption Setting 80, 81
Component Out Jack 11, 18, 19, 21, 28
Connecting to Analog TV 27
Connecting to Antennas 23-26
Connecting to Audio System 32, 33
Connecting to HD Monitor(DVI type) 30
Connecting to HD Monitor(RGB type) 29
Connecting to HD Monitor(Y/Pb/Pr type) 28
Connecting to VCR 31
Connection Overview 22

D

Digital Audio Out (Optical) Jack 21, 32
Digital Audio Out Setting 74, 75
Digital Audio Signals 14
Digital Output 74
Digital TV Input Setting 84
Dish Selection 62
Display Formats 11
Dolby Digital 14, 74, 75
DVI-HDTV Port, Cables 18, 19

E

Elevation 63

F

Favorite Channel 44
Favorite Channel Edit 68, 69
FCC Regulations 1
Features 8
Format button, front panel 34
Format button, remote control 37
Format setting 11
 1080i Format 11, 28, 29, 30
 720p Format 11, 28, 29, 30
 480p Format 11, 28, 29, 30
 Variable 1/2/3 Format 11
 Auto DVI Format 11
 Video 1/2 Format 11, 21, 27, 31

Front Panel 34

Future Purchase 59

Future Viewing 52

G

Guide 56

H

Help 8, 17, 51, 95, 96
Hook-up Help 8, 17, 70, 96

I

Initial Setup 41, 62-65

L

Limited Warranty 100
Location 63
Locks Setting 86-91
Lock System 86

M

Messages Checking 61
Movie Rating 88

N

NTSC 10

O

Output Channel Setting 82
Out to TV Jack 21
Out to TV Setting 83

P

PCM (Digital) 14, 74, 75
Phone Jack 21
Purchase List Managing 60
Purchasing DIRECTV® Pay Per View programs 53

R

Receiving Signals 23-26
Remind List 58
Remote Control, buttons and functions 35-37
Remote Control Codes for Other Components 39, 40
Remote Control Programming 38
Replace Card 93
RF Jacks, Cables 18, 19
RGB/DVI-HDTV Out Ports 21

S

SAP 15, 76
Satellite In Jack 21, 24-31
Signal Strength 64
Software License Agreement 101
Software Upgrading 94
Specifications 97
Spending Limit 91
S-Video Jack 18-21
System Test 92

T

Testing the System 92
Tilt 63
Troubleshooting 98, 99
TV Connection 27-30
TV Rating 89, 90
TV Signal Formats 10

U

Unlocking System 86

V

Variable 1, 2, 3 11, 34
VCR Connection 31
Video Out Jacks 20, 21

Y

YPbPr (component) out jack 11, 18, 19, 21, 28

W

Warranty 101
Wide Mode 12, 13, 78, 79

Z

Zip Code 63



Printed in KOREA

Contact DIRECTV with questions about
service, programming or billing:
1-800-DIRECTV (347-3288)
www.DIRECTV.com

Contact Sony with questions about your
Digital Satellite Receiver:
1-800-838-SONY (7669)

Sony  line

www.sony.com

www.sony.com/support